

AP1000[®] Overview

AP1000[®] is a registered trademark in the United States of Westinghouse Electric Company LLC, its subsidiaries and/or its affiliates. This mark may also be used and/or registered in other countries throughout the world. All rights reserved. Unauthorized use is strictly prohibited. Other names may be trademarks of their respective owners.



©2011 Westinghouse Electric Company LLC - All Rights Reserved





Agenda

- **AP1000 Design Philosophy**
 - AP1000 Passive safety functions
 - AP1000 Robustness against external events
- **AP1000 Licensing Activities & Status**
- **AP1000 Deployment Activities & Status**



AP1000 Plant Design Objectives

- **Greatly Simplified Plant**
 - Construction, Maintenance, Operation, Safety
- **Increased Operation and Safety Margins**
 - Design Basis Accidents, PRA (core melt prevention & mitigation)
- **Competitive Cost of Power, Less Than Coal Plant**
- **Short Construction Schedule** (3 Years for nth of a kind)
- **Modular Construction**, Leverage simplification to maximize certainty of cost, schedule, and enhance quality through workshop fabrication
- **Licensing Certainty & Reduced Customer Costs**
 - NRC Final Design Approval / Certification – extensive testing of passive systems
 - Pre-Engineered / Pre-Licensed Standard Design: Reduce Costs, Increase Licensing Certainty
- **No Plant Prototype; Proven Components / Systems**
- **Improved Availability**, Inspection, ORE, Maintenance

Evolutionary PWRs

- Updates of current 3 & 4-loop designs
- Extensive, safety-grade support systems
- Off-site ac for safety action and safety diesel or turbine -driven generators as backup
- Greater reliance on operator action
- Ultimate heat sink: heat exchangers/water systems

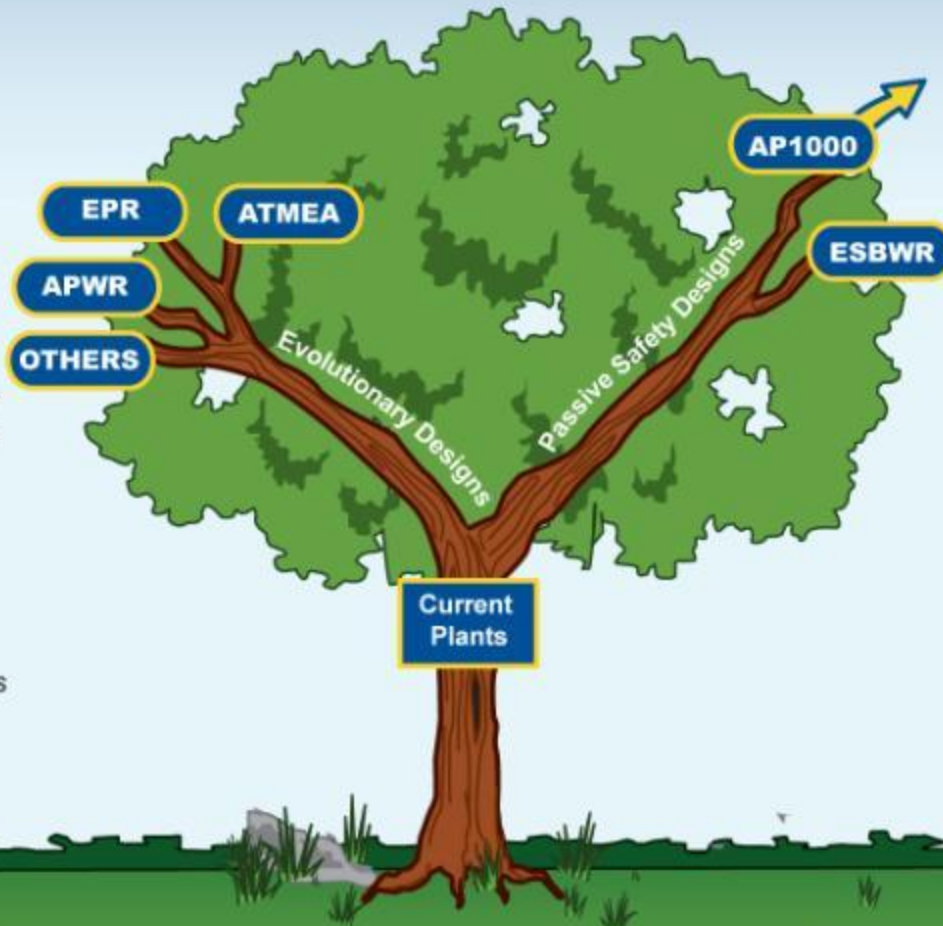

Why AP1000 passive designs?

- Less concrete & steel/MWe
- Simpler, less equipment, less safety-grade equipment, no safety-grade pumps
- Fewer Seismic 1 structures
- Shorter construction schedules
- Less maintenance, maintenance-free canned reactor coolant pumps, simpler Tech Specs
- Much less reliance on operator action to mitigate accidents (72 hours)
- Independent of off-site ac power to operate safety systems
- Ultimate heat sink: ambient air

The preferred technology in the US and China



Westinghouse AP1000

A compact station

- 3415 MWt. Primary system
- 1100 MWe Class
- 2-loops, 2 steam generators

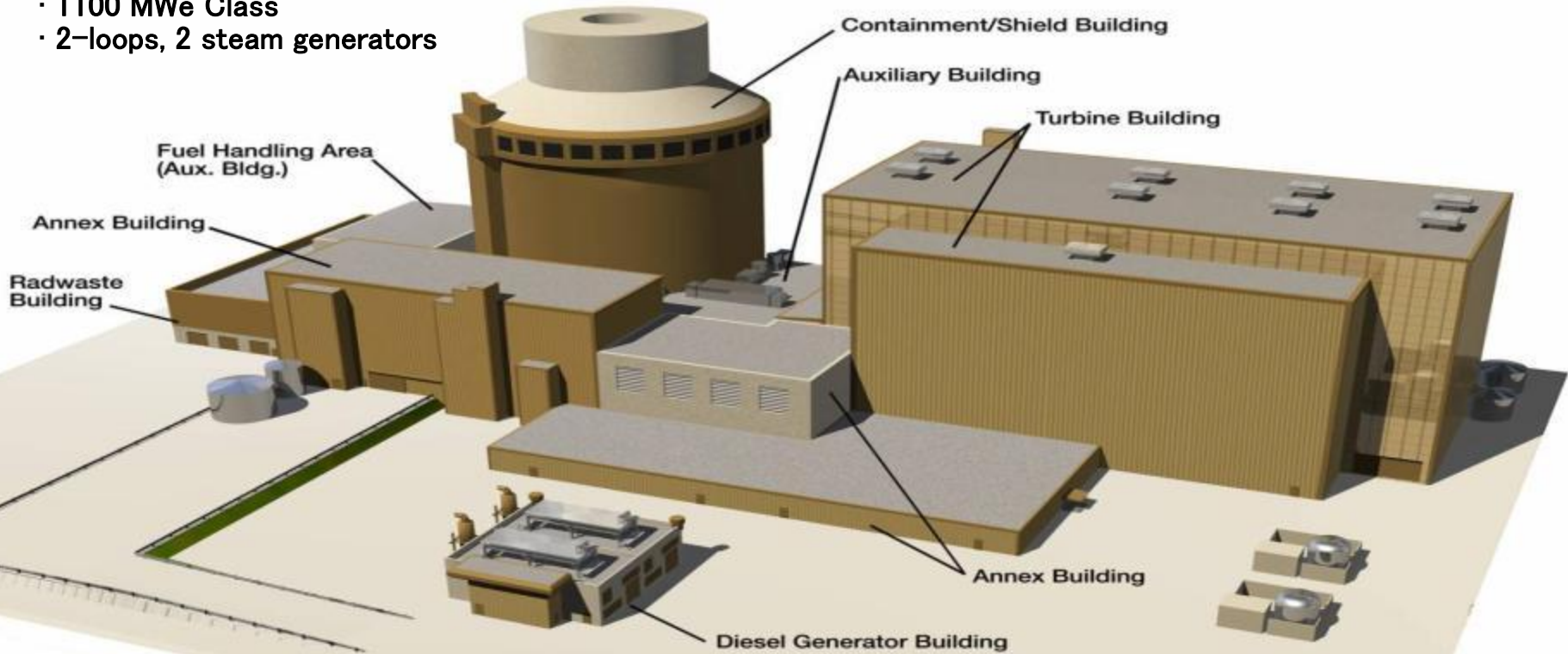



AP1000 Approach to Safety

- **Passive Safety-Related Systems**

- Use “passive” processes only, no active pumps, diesels,
 - One time alignment of valves
 - No support systems required after actuation
- Greatly reduced dependency on operator actions
- Mitigate design basis accidents without active systems
- Meet NRC PRA safety goals even without credit of active systems

- **Active Defense in Depth-Related Systems**

- Reliably support normal operation
 - Redundant equipment powered by onsite diesels
- Minimize challenges to passive safety systems
- Not required to mitigate design basis accidents

AP1000 Approach to Safety Defense In Depth



- First Level is usually the Defense in Depth active features
 - Automatically actuated before passive features
 - High quality industrial grade equipment
- Another level is the passive safety features
 - Provides safety case for licensing
 - Highest quality nuclear grade equipment
- Functional diversity within the passive features provides additional levels
 - Example; passive feed/bleed backs up PRHR HX
- Available for all shutdown and at-power conditions
 - More likely events have more levels of defense



Simplification of Safety Systems Dramatically Reduces Building Volumes

Standard PWR

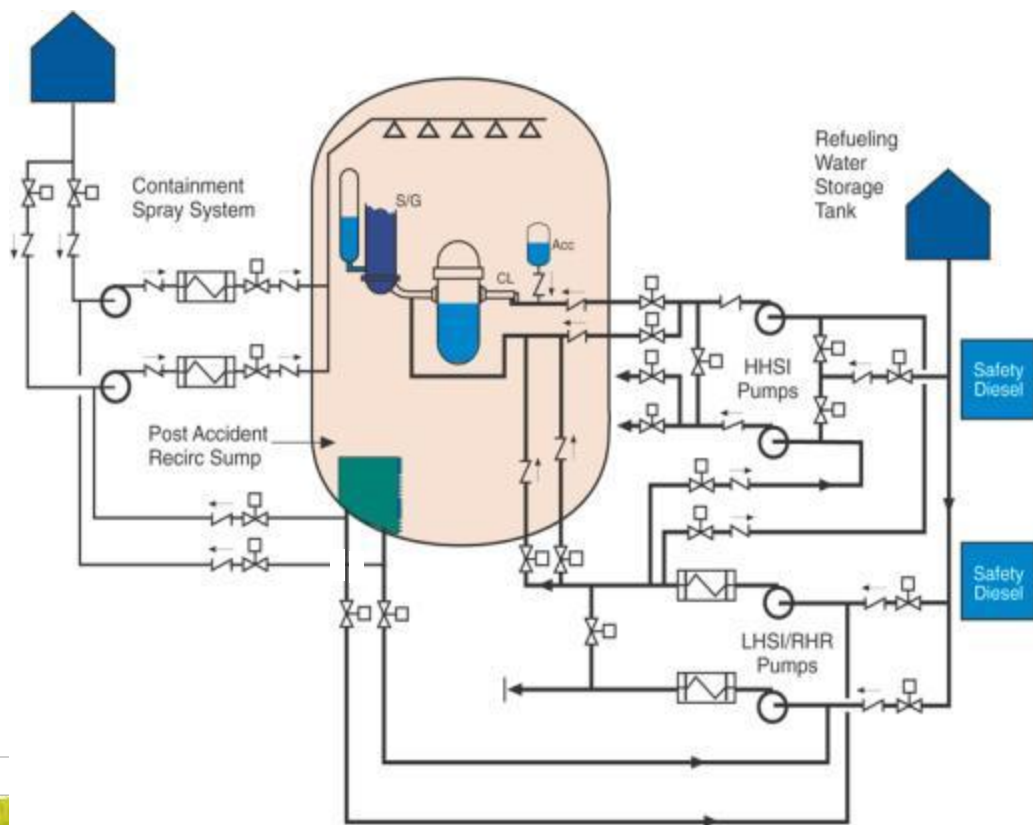

AP1000

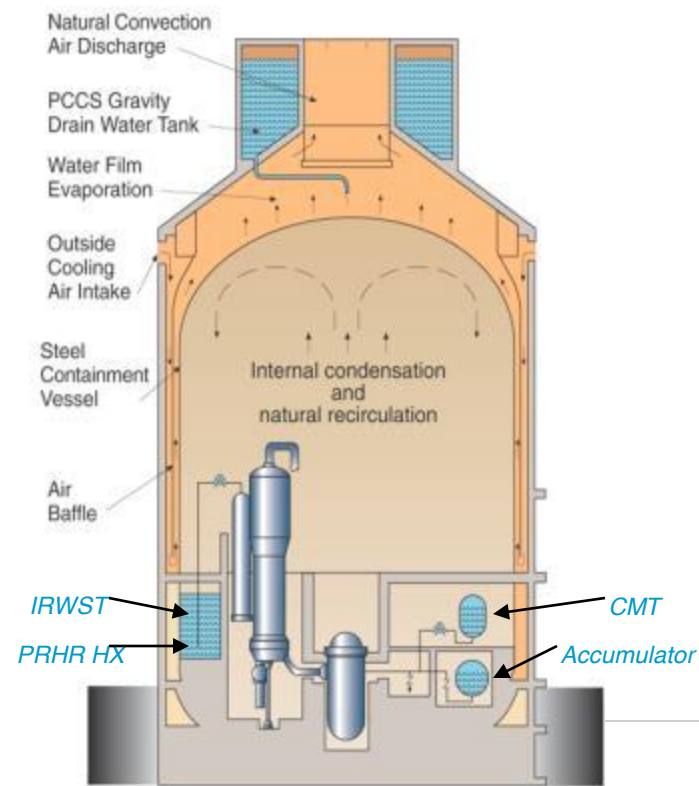

Simplification: Smaller Footprint

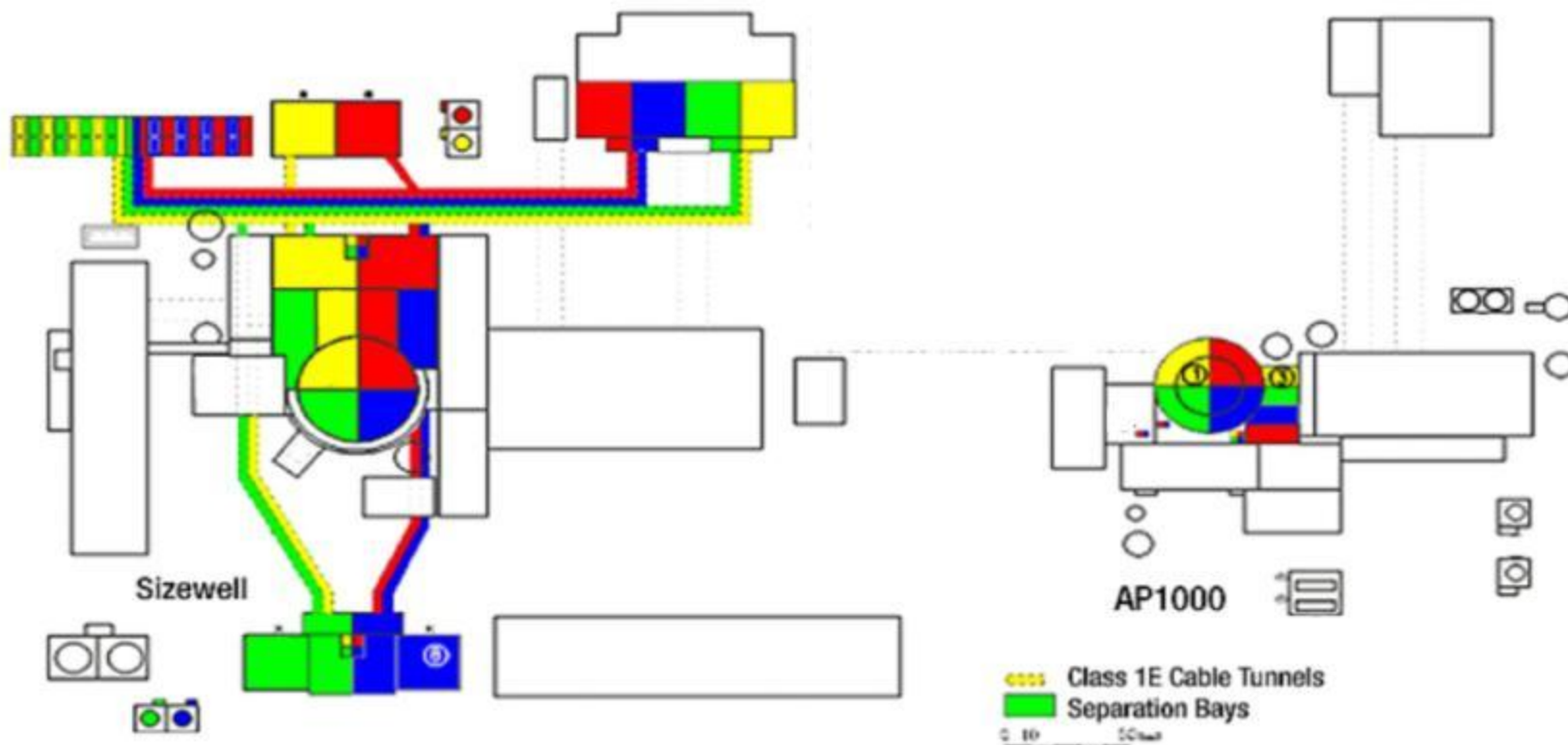

Evolutionary PWR

AP1000

Size Matters





Major Safety Advancements of AP1000

- No Reliance on AC Power; Long Term Plant Safety Assured without Active Components (Natural Forces Only)
 - For Station Blackout (SBO), AP1000 meets aggressive 72 hours coping time requirements for passive plants
 - Active plants SBO coping period requirement is 8 hours or less
 - Significant risk reduction for loss of power events:
 - For advanced active plants design, LOOP / SBO events are a dominant contributor to the Core Damage Frequency (in the range of 25+%)
 - AP1000 CDF contribution for loss of Offsite Power / SBO is 0.4%
- No Operator Action Required to Assure Safety
- In Severe Accidents, Reactor Vessel Cooling Keeps Core in Vessel
- Large Margin to Safety Limits
- Defense in Depth - Active Systems Provide ADDITIONAL first line of defense



Major Safety Advancements of AP1000

Event/Threats Response Summary

Events /Threats	Westinghouse AP1000
Earthquakes and Floods	<p>Seismic Design: AP1000 designed to withstand an earthquake that would happen once in every 10,000 years. Plants are being sited in seismically stable regions</p> <p>Robust: Designed to withstand other natural disasters: flooding, tornados, tsunamis, hurricanes.</p>
Station Blackout (no AC power sources)	<p>AP1000 can be safely shut down and maintained during a station blackout for 7 days. The advanced passive safety features rely on natural forces such as gravity, natural circulation, condensation and convection. The ultimate heat sink is the atmosphere.</p> <p>Power Sources</p> <ul style="list-style-type: none"> • Redundant safety-related DC batteries support safe shutdown for 72 hours (3 days). • Two redundant 80 kw ancillary diesel generators provide cooling water to the containment shell and spent fuel pool. Ancillary diesels can run for 4 days with no offsite support. • Two redundant 4 MW standby diesel generators can power equipment for 7 days with no offsite support (not required to cope with station blackout) <p>Water Sources</p> <ul style="list-style-type: none"> • Passive Containment Cooling Tank provides cooling to the containment shell for 72 hours • Ancillary Storage Tank provides cooling to the containment shell and to the spent fuel pool after 72 hours for a period for 4 more days

Major Safety Advancements of AP1000 Event/Threats Response Summary



Events /Threats	Westinghouse AP1000
Containment Integrity	<p>Containment Design: The 44.5 mm (1¾") steel containment is a high integrity steel pressure vessel surrounded by a shield building that protects it from missiles, including aircraft impact.</p> <p>Hydrogen Management: Battery powered hydrogen igniters & passive hydrogen recombiners prevent explosions</p>
Spent Fuel Pool Integrity and Cooling	<p>Structure: Spent fuel pool features 1+ m (3-5') thick, heavily reinforced concrete structures lined with steel</p> <p>Makeup Water: Spent fuel will remain covered with water sources located in the spent fuel building for at least 3 days. Following 3 days, water is provided by the ancillary storage tank.</p> <p>Robust Building: Designed for protection against seismic events, natural disasters and aircraft impact.</p>
Control Room Habitability	<p>Heavily shielded room with a 72-hour air-pressurization system. Control room dose minimal</p>

AP1000 Passive Core Cooling System Eliminate the need for AC Power



- **Passive Residual Heat Removal (PRHR HX)**
 - Natural circ. heat removal replaces auxiliary feedwater pumps
- **Passive Safety Injection**
 - Core Makeup Tanks (CMT)
 - Full RCS pres, natural circ. inject (replaces high head injection pumps)
 - Accumulators (ACC)
 - Similar to current plants
 - In-containment Refueling Water Storage Tank (IRWST) Injection
 - Low pres (replaces low head injection pumps)
 - Containment Recirculation
 - Gravity recirc. (replaces pumped recirc)
 - Automatic RCS Depressurization
 - Staged, controlled depressurization

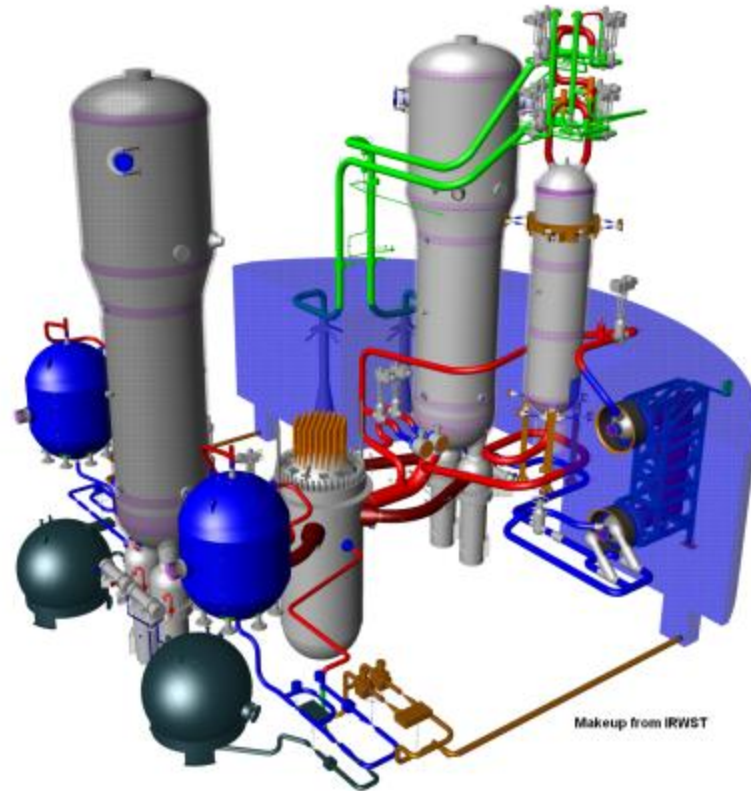

Passive Safety Injection Operation During a LOCA

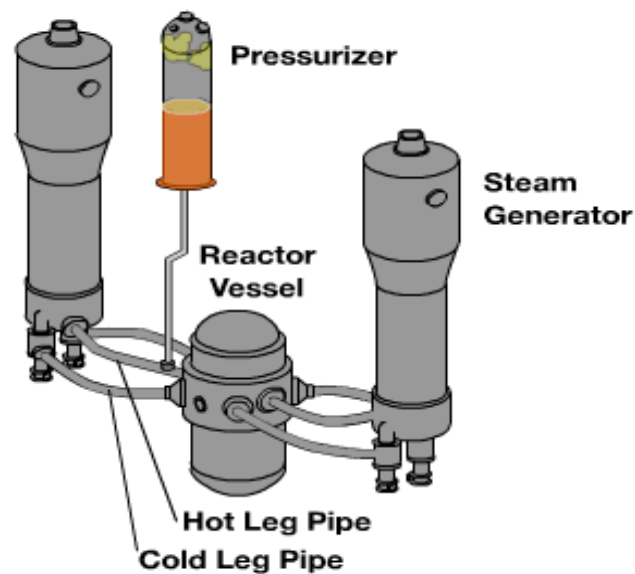



Passive Containment Cooling System

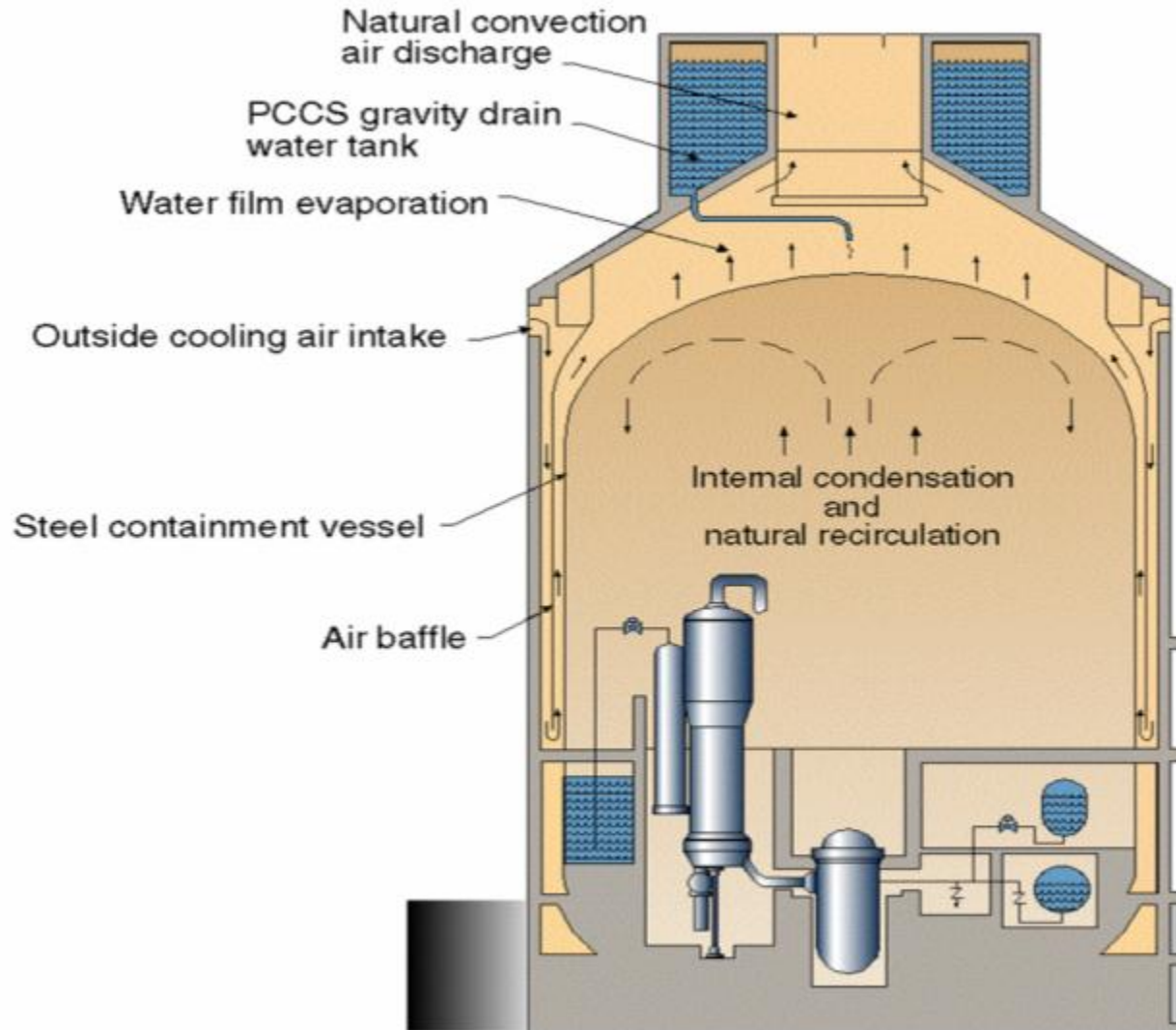

AP1000 PCS cools outer surface of steel containment shell using natural circulation of air and water evaporation.

AP1000 ultimate heat sink is the atmosphere.

Passive Containment Cooling Operation During a LOCA

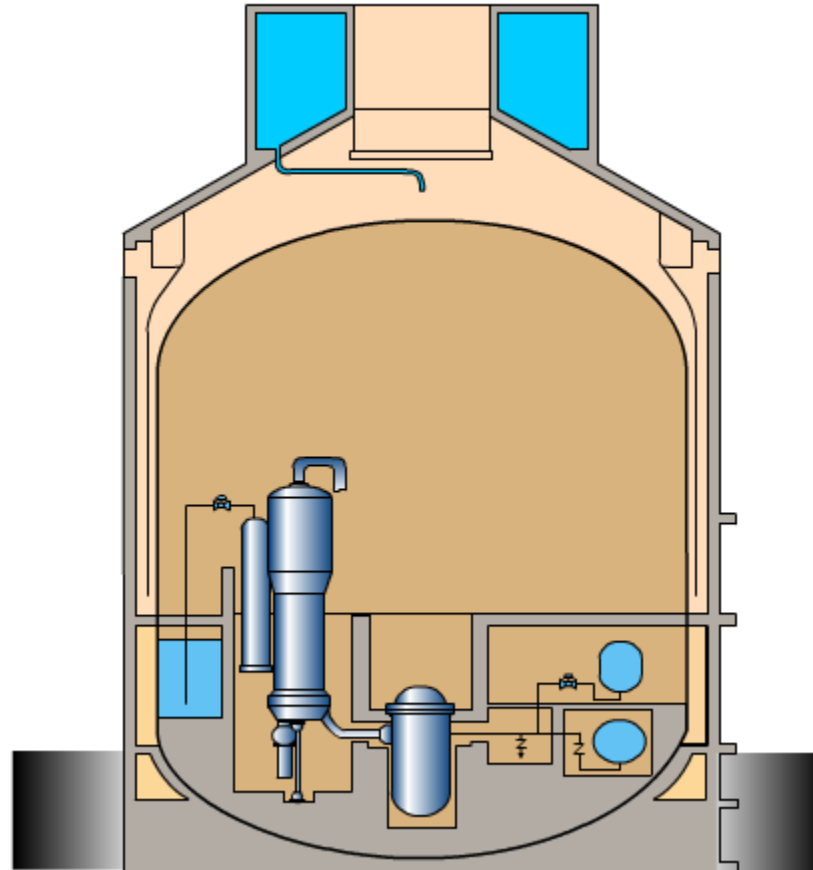



Enhanced Shield Building Design

Aircraft Crash Requirements and Seismic Performance

Shield Building Design Features

Hardened design to meet Aircraft Crash requirements

- RC/SC connection redesigned to improve ductility
- Reinforced cylindrical wall with tie bars between steel plates
- Increased SC plate thickness to improve strength and ductility
- Revised the air inlet/ tension ring design for constructability and strength

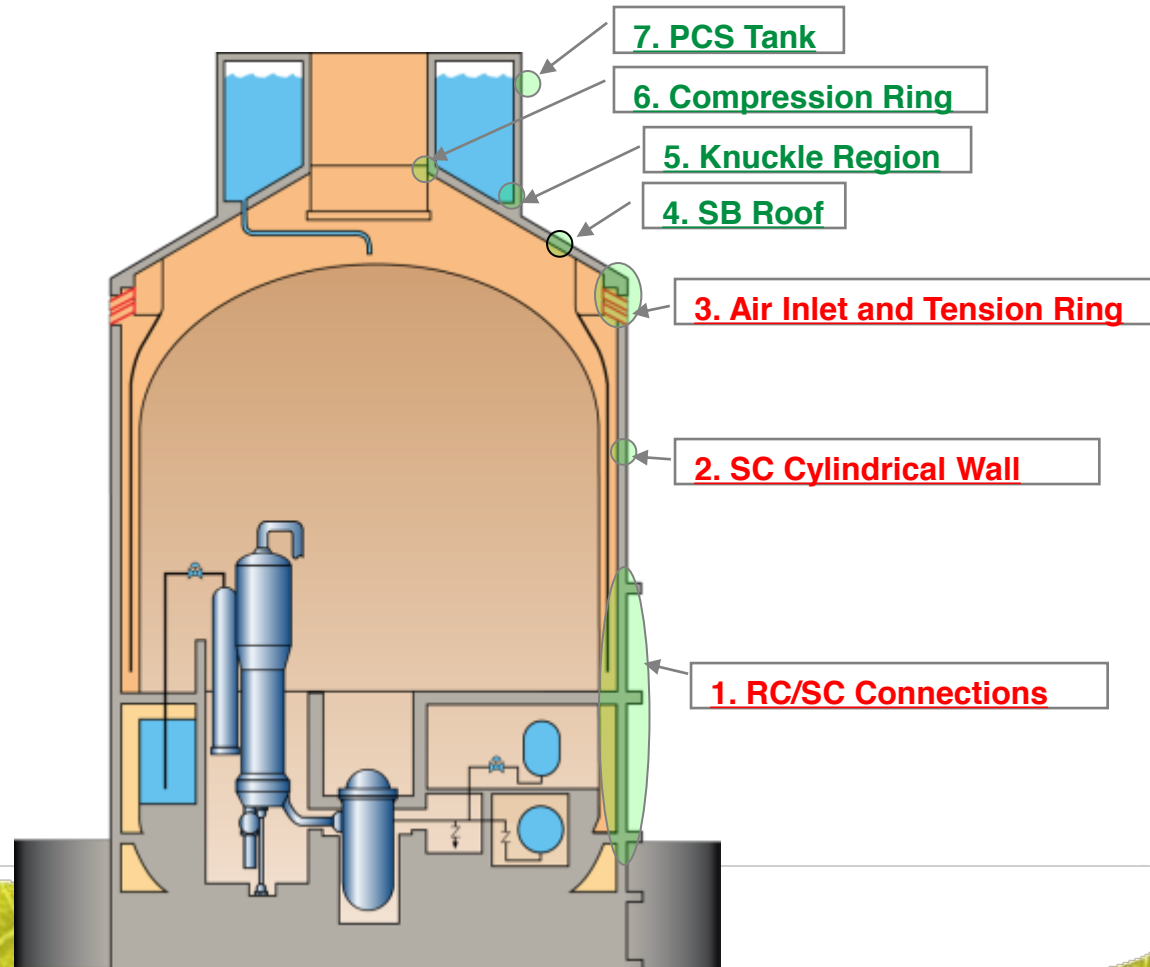



Severe Accidents Addressed

- In-Vessel Retention (IVR)
 - External reactor vessel cooling
 - Provides reliable means of cooling damaged core
 - Prevents vessel failure
 - AP600/AP1000 tests and analysis of IVR reviewed by U.S. NRC
- High Pressure Core Melt
 - Eliminated by ADS
- Hydrogen Detonation
 - Prevented by igniters and passive autocatalytic recombiners
- Steam Explosions
 - In-Vessel – no RV failure
 - Ex-Vessel – eliminated by IVR
- Core Concrete Interaction
 - Eliminated by IVR

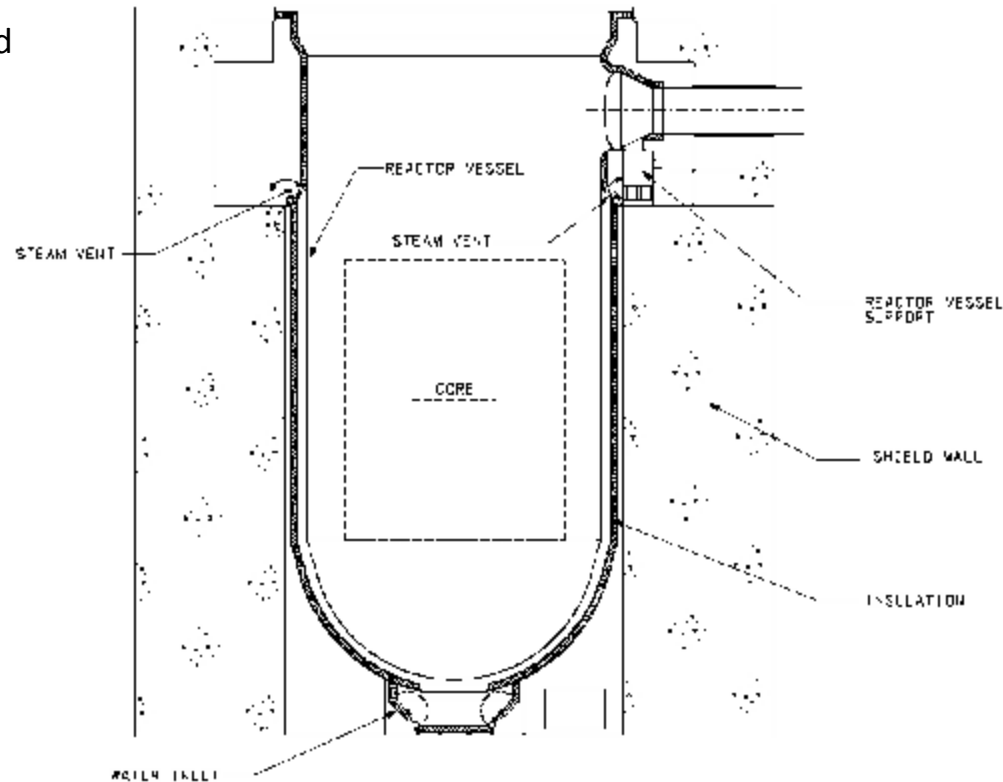



Why In-Vessel Retention

- 1. PRA/PSA shows ex-vessel phenomena risk significant. IVR prevents ex-vessel phenomena**
- 2. Simple strategy for operators: Provide water**
- 3. Core melt does not attack containment barrier**

AP1000 In-vessel Retention Capability

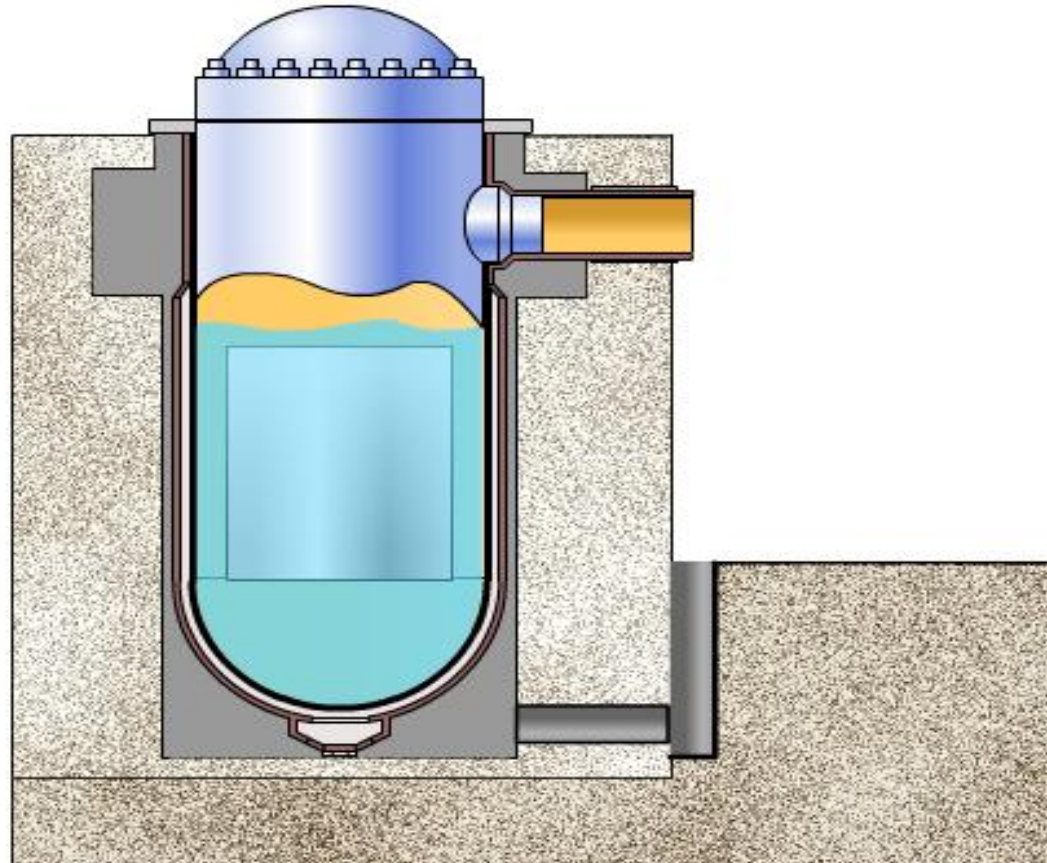

Spent Fuel Pool Cooling Lines of Defense



- **During Normal and Abnormal Conditions, the active defense in depth and duty systems provides highly reliable spent fuel pool cooling**
 - Spent Fuel Cooling System, Residual Heat Removal System, Component Cooling Water System, Service Water System all have 2*100% design for active components
 - Offsite power backup provided by 2*100% Onsite Standby Diesel Generators with automatic startup on loss of offsite power
- **For unlikely events with extended loss of AC power (station blackout) and/or loss of heat sink, the safety case for the AP1000 is provided by passive means**
 - Simple or no operator actions are required for 72 hours
 - Beyond 72 hours, one of the two PCS Recirculation Pumps (powered by the Ancillary Diesel Generators) is used to pump water from the Ancillary Tank to the Spent Fuel Pool. The Ancillary Tank contains sufficient volume of makeup water to continue this action from 72 hours to approximately 7 days.
- **Even for Extreme Events, the Spent Fuel Pool spray system provides an additional line of defense to provide fuel cooling**



Spent Fuel Pool

AP1000 Makeup Capability – 7 days

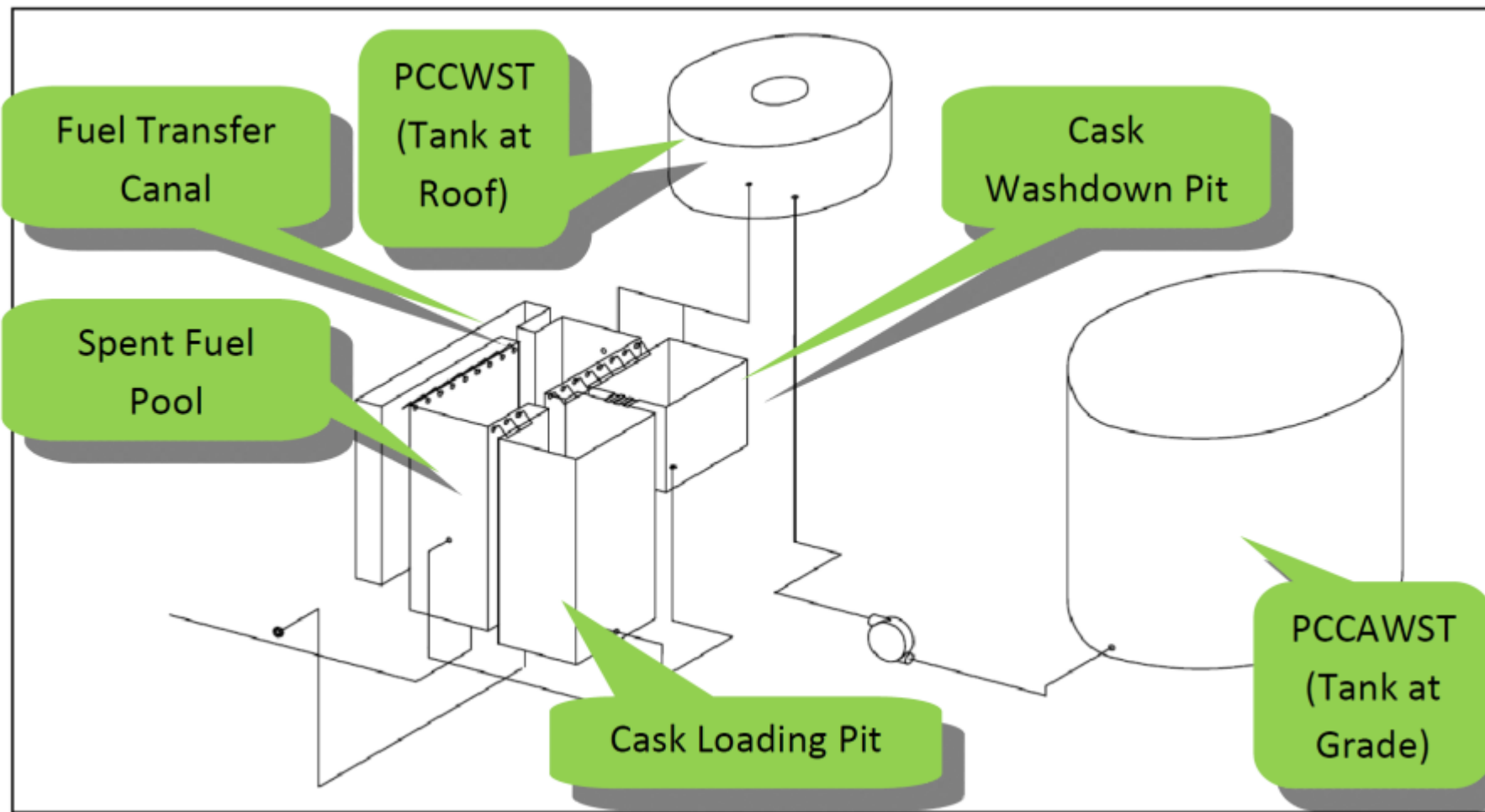



Spent Fuel Pool

AP1000 Makeup (in addition to 7 day capability)

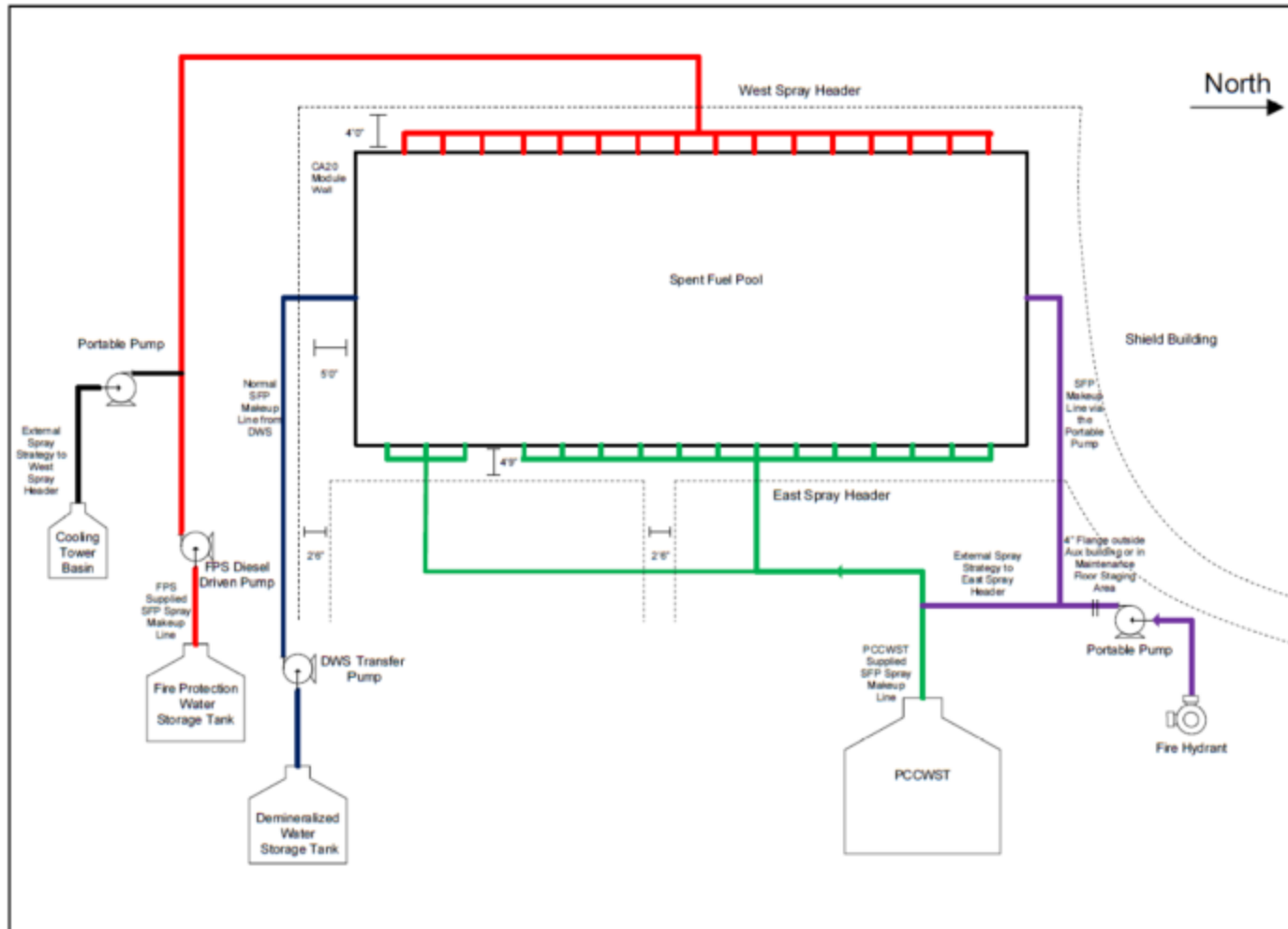

AP1000 Provides Safety and Investment Protection

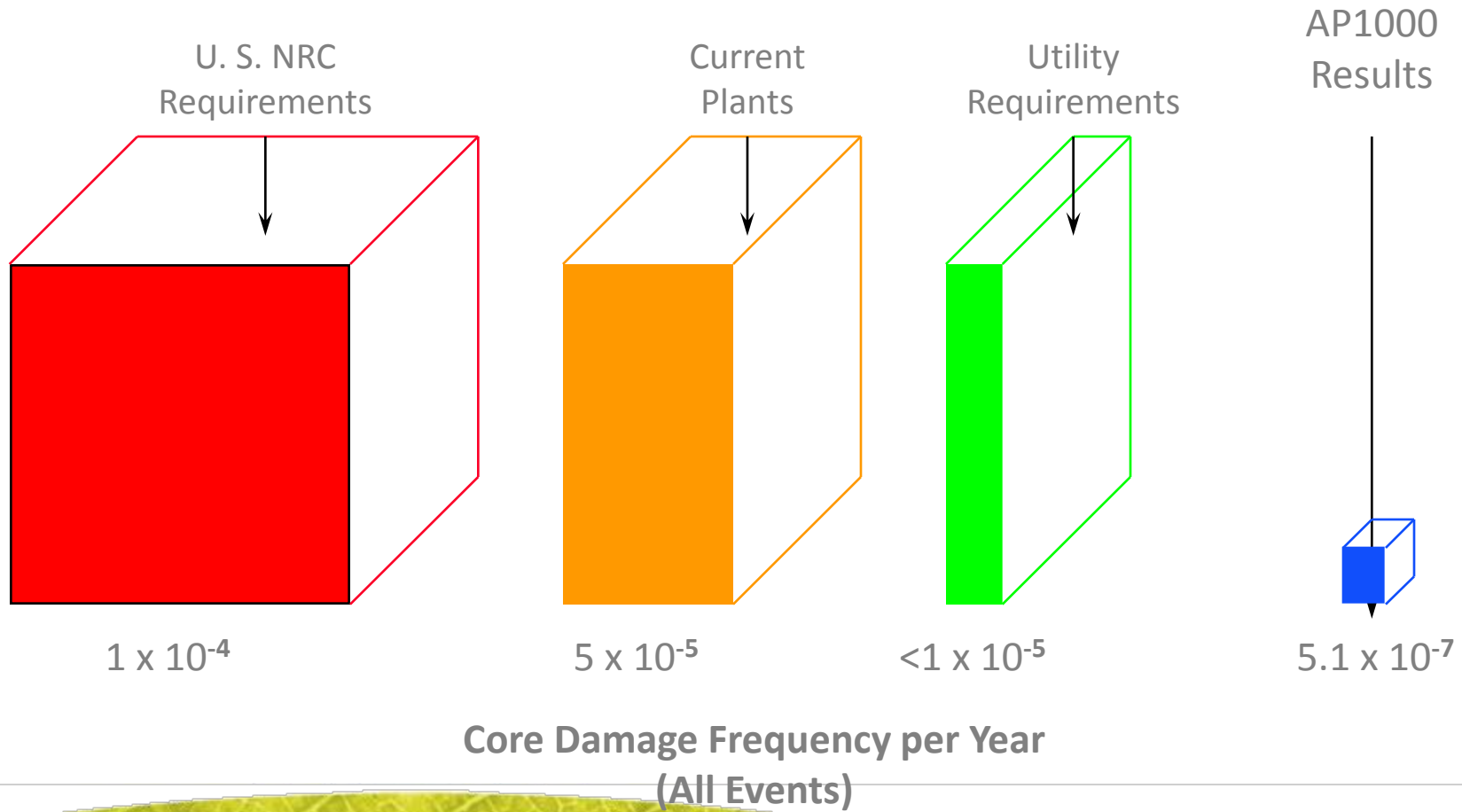

Comparison of Contribution of Loss of Offsite Power and SBO to Core Damage Frequency (CDF)

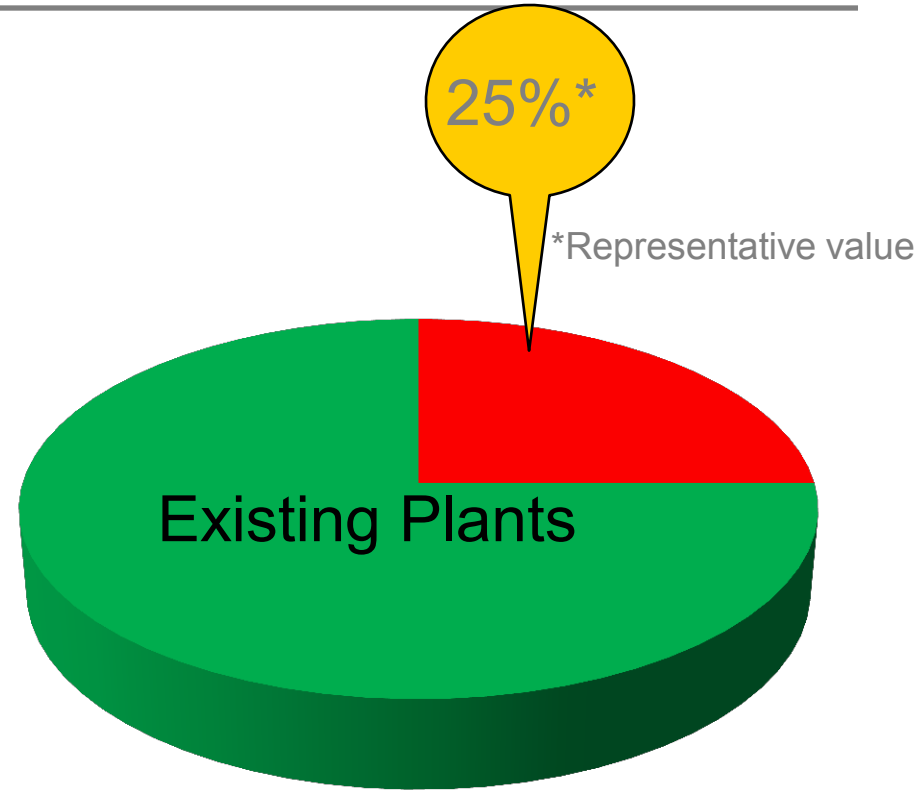
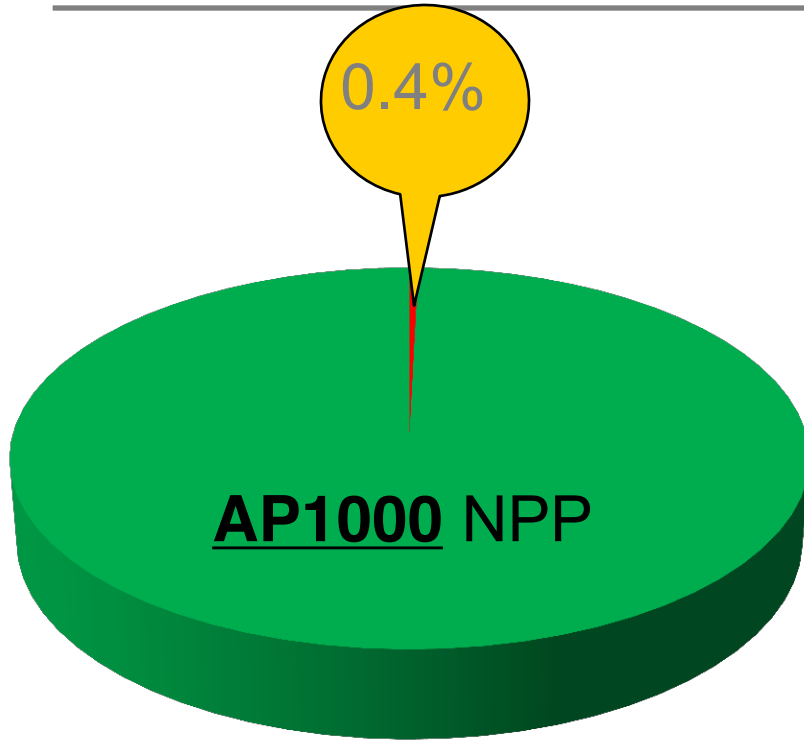

AP1000 Passive Safety Concept achieves a dramatic reduction in risk resulting from loss of offsite power events (e.g. Station Blackout) compared even to the most advanced active PWR designs

AP1000 Licensing & Deployment Activities





AP1000 Licensing Activities & Status

- **US NRC Design Certification**
 - Regulatory Certainty
 - Amendment Objectives
 - Special Topic Status
- **International Licensing Activities**
 - UK GDA
 - China
 - Additional International Activities



Rulemaking History

- AP1000 (Revision 15) Design Certification rule was approved by the NRC Commissioners December 30, 2005
- In March 2006 Westinghouse started submitting Technical Reports to address Design Related COL open items. Over 141 Technical Reports submitted
- Revision 17 of DCD was submitted September 15, 2008 and represented a “Design Freeze” point for licensing review
- Revision 18 DCD issued on December 1, 2010 for rulemaking
- FRN Issued Proposed Rule for Public Comment on February 24, 2011
- Revision 19 DCD issued on June 13, 2011 providing resolution of all known NRC open confirmatory items associated with NRC’s Final Safety Evaluation Report





Amendment Objectives

- **Increase Standardization** - Reduce COL applicant licensing risks by closing design related COL open items and Design Acceptance Criteria (DAC)
- **Increase Site Applicability** - Environmental parameters expanded and Certified Site Interface expanded from hard rock to hard rock and all soils
- **Shield Building Design Improvements** – Modifications to comply with emerging Aircraft Impact requirements and to facilitate modular construction
- **Incorporate Changes Due to Design Finalization** - Design improvements were incorporated in accordance with 10 CFR Part 52.63(a)
 - Regulatory
 - Design Centered Working Group
 - Design Finalization

UK GDA

ND/EA Quarterly Report

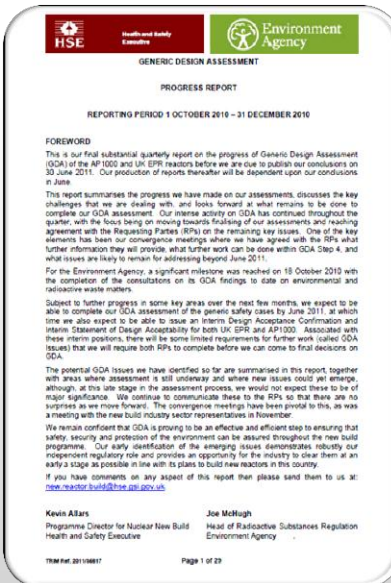

We have not identified any showstoppers at this point, but some of the observations are likely to result in design changes. In these cases we are seeking to agree the principal aspects of the changes within GDA Step 4. Subject to further progress in some key areas over the next few months, **we expect to be in a position to consider issuing an Interim DAC for both UK EPR and AP1000 in June 2011.**

In previous quarterly reports we have noted the steps that Westinghouse had taken to improve its project management arrangements, and to provide more resource to the GDA project. **We are pleased to say that we have seen a concerted effort by Westinghouse to drive forward on GDA, propose solutions to clear a number of issues, and identify credible forward work plans.** We hope to see this level of effectiveness maintained for the remainder of the GDA programme in order to allow us to come to a meaningful GDA conclusion.

www.hse.gov.uk/newreactors/reports/gda-q4-10.pdf



UK GDA - Weightman Report

- The Interim Weightman Report outlines 26 recommendations, it groups these recommendations into a number of sub categories including: -
 - General
 - Relevant to the Regulator
 - Relevant to the Nuclear Industry
 - Way Forward
- Response on interim report requested by 15 June
 - Westinghouse response has been provided commenting on recommendations relevant to nuclear industry
 - Response will be made public, timely likely to align with issuance of final Weightman report

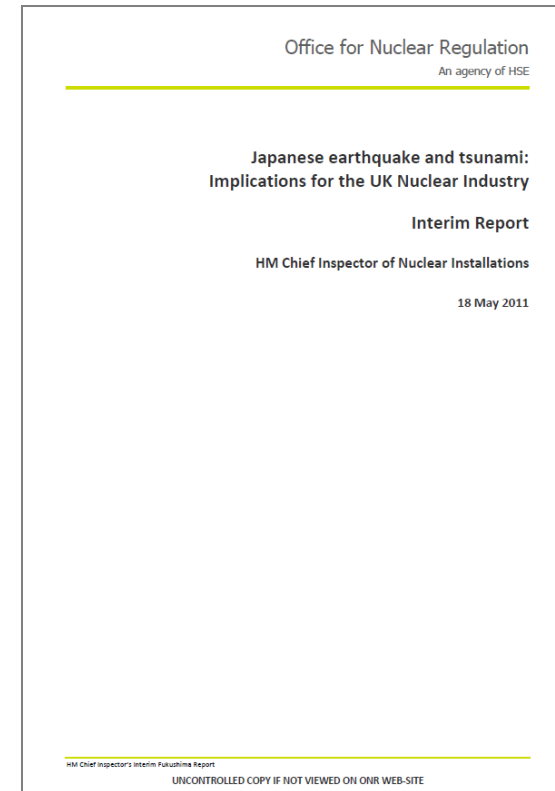



Other International Licensing Activities

Additional Licensing Work Throughout The World

- **China** (in final FSAR Development)
- **India**
- **Canada**
- **Scandinavia, Central Europe, Asia, Middle East, Africa, and South America**

The worldwide nuclear community is finding AP1000 safe and licensable!



Confidence from Being Part of a Global Fleet

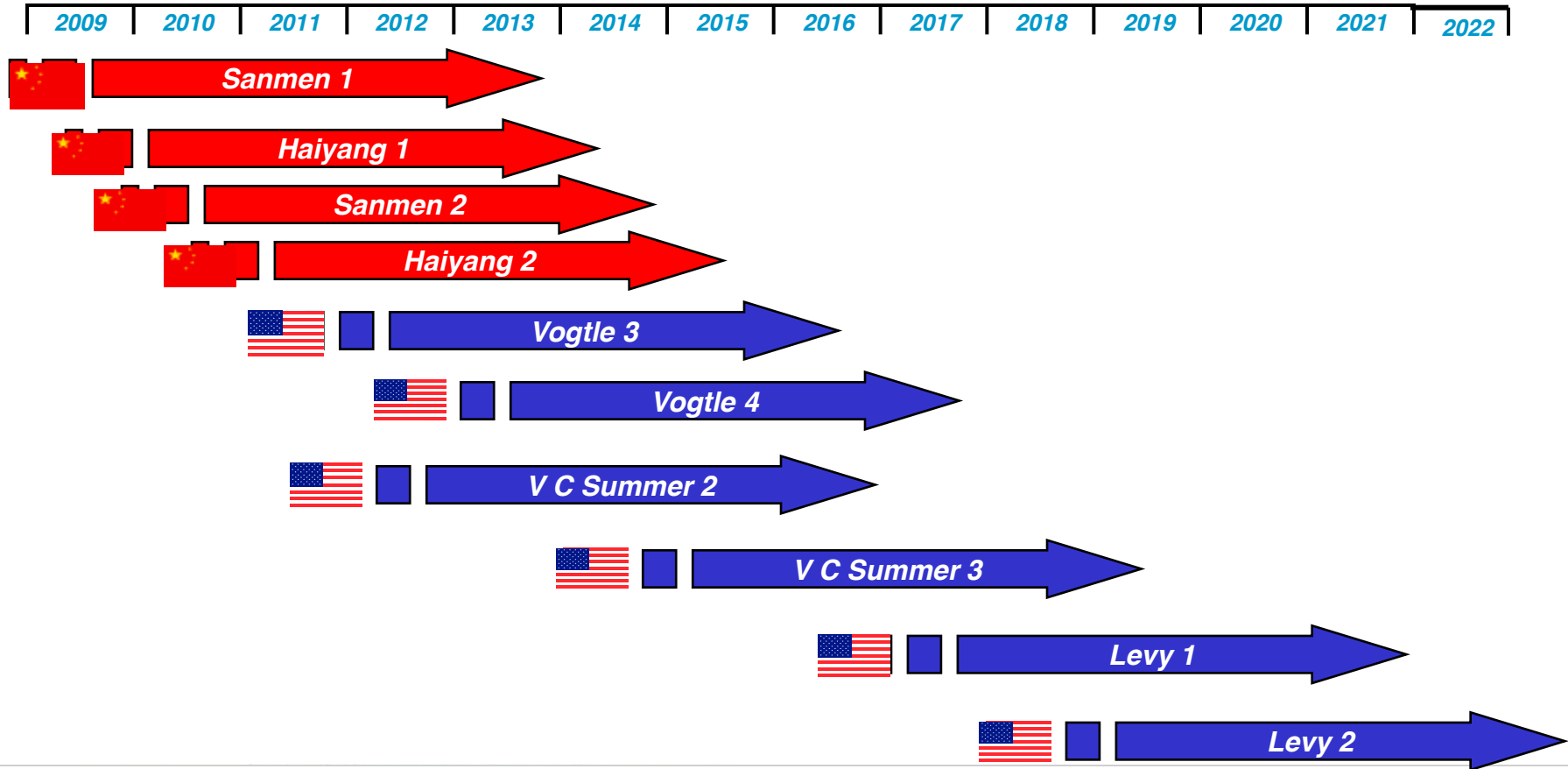



What Influenced the People's Republic of China's Decision to Consider AP1000?

- New generation of advanced nuclear technology
- New, passive safety features
- Smaller Nuclear Island and building footprints
- Smaller number of safety components (reducing supply chain issues)
- Fundamental modular approach
 - Reducing construction and fabrication quality risks
 - Optimizing plant construction time
- Reduced overall schedule and cost risks
- Technology Transfer provisions support People's Republic of China (PRC) long-term commercial nuclear strategy
- Existing AP1000 Design Certification by the U.S. Nuclear Regulatory Commission (NRC)
- Westinghouse International Reputation and Pedigree



AP1000 Construction in China

Sanmen Unit 1 - March 31, 2009



Sanmen Unit 1 - Containment



Haiyang Unit 1 - January 30, 2010



Construction Activity SM1: Setting of CA20





Positive Effects of Modular Construction

	Feb 2007 Plan	Actual	Delta
First Concrete Milestone Completed	31-Mar-09	31-Mar-09	0
Auxiliary Building Module Set in Place	31-May-09	29-Jun-09	1
CVBH Set in Place	30-Jun-09	21-Dec-09	6
CV 1st Ring Set in Place	31-Dec-09	18-Mar-10	3
CV 2nd Ring Set in Place	31-May-10	31-May-10	0

With the setting of the CV 2nd Ring, against the construction schedule milestones, Sanmen Unit 1 has recovered the 6-month delay in setting the CVBH.

This was achieved as a result of modular construction.





Primary Pressure Vessel Procurement

Haiyang SG Channel Head Forging



Haiyang #1 Closure Head

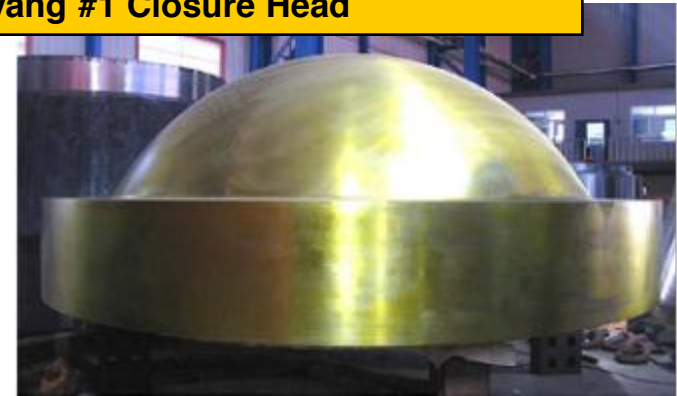

Sanmen #1 RV Upper Shell



RCP Casing from Sheffield Forgemasters





Unit 1



Unit 2

Unit 3



Vogtle 3&4

Site Layout



Unit 4

Unit 3

Unit 2

Unit 1





Summary

- AP1000 provides passive safety features for design basis events and defense in depth systems to minimize reliance on passive safety features
- AP1000 Passive Design provides unique capabilities in response to beyond design basis events
- AP1000 Design has a high degree of maturity, including licensing reviews completed or ongoing in numerous countries worldwide
- AP1000 robustness and long coping periods provide a strong foundation to address evolving licensing requirements