

Reversible Solid Oxide Fuel Cell Technology for Green Fuel and Power Production

by Nguyen Q. Minh and Mogens B. Mogensen

A reversible solid oxide fuel cell (RSOFC) is a device that can operate efficiently in both fuel cell and electrolysis operating modes. Thus, in the fuel cell mode, an RSOFC functions as an SOFC, generating electricity by electrochemical combination of a fuel (hydrogen, hydrocarbons, alcohols, etc.) with air (oxygen in the air). In the electrolysis mode, an RSOFC functions as an electrolyzer (in this case, referred to as a solid oxide electrolysis cell or SOEC), producing hydrogen (from water) or chemicals such as syngas (from mixtures of water and carbon dioxide) when coupled with an energy source (fossil, nuclear, renewable). Figure 1 illustrates the operating principles of the RSOFC. The RSOFC has the following attractive features (demonstrated or potential): compatibility (environmentally compatible with reduced CO₂ emissions in power generation mode), flexibility (fuel flexible and suitable for integration with any type of energy sources), capability (useful for different functions), adaptability (suitable for a variety of applications and adaptable to local energy needs), and affordability (competitive in costs).¹ The RSOFC thus possesses all the desired characteristics to serve as a technology base for green, flexible, and efficient energy systems in the future (Fig. 2).

Sustainable energy systems based on the RSOFC for the future is feasible. An example of such a system is shown schematically in Fig. 3. In this system, the RSOFC, operating in the electrolysis mode, uses a renewable energy supply (e.g., solar, wind, hydro) to produce hydrogen (from H₂O)

or syngas (H₂+CO) (from mixtures of H₂O and CO₂). The chemicals produced can be used to generate power by the same RSOFC operating in the fuel cell mode or can be stored or converted to other chemicals/fuels for subsequent uses. Similarly, the RSOFC can generate power from biomass-derived fuels and the electricity generated can then be used for a variety of power generation applications.

The RSOFC is both the SOFC and SOEC incorporated in a single unit. Since the SOEC is the SOFC operated in reverse mode and traditionally derived from the SOFC, the RSOFC being developed is typically based from the more technologically advanced SOFC. Thus, materials for the RSOFC are those commonly used in the SOFC, *i.e.*, yttria stabilized zirconia (YSZ) for the electrolyte, perovskites (such as lanthanum strontium manganese oxide or LSM, lanthanum strontium cobalt iron oxide or LSCF) for the oxygen electrode, nickel/YSZ cermet for the hydrogen electrode and for stacking, conductive oxides (such as lanthanum strontium chromium perovskite or LSC) or stainless steels for the interconnect (depending on the operating temperature). Like the SOFC, the RSOFC operates in the temperature range of 600°-1000°C. Specific operating temperature depends on cell/stack designs and selected materials.^{2,3}

Solid Oxide Fuel Cell Technology

The RSOFC is fundamentally and technologically based on SOFC technology. In the past 20 years, the SOFC has received significant attention as a clean and efficient energy conversion technology for a variety

of practical fuels and has been under development for a broad spectrum of power generation applications. The key features of the SOFC are its all solid state construction (ceramic and metal) and high operating temperature (600°-1000°C). The combination of these features leads to a number of distinctive and attractive attributes for the SOFC including cell and stack design flexibility, multiple fabrication options, multi-fuel capability, and operating temperature choices.

SOFC cells can be configured to be self supporting (electrolyte-supported, anode-supported, cathode-supported) or external supporting (interconnect-supported, substrate-supported). Stack designs being developed for the SOFC include the tubular design, the segmented-cells-in-series design, the monolithic design, and the planar design, with the planar design currently being the most common. These design options permit flexibility to shape the SOFC into a structure having the desired electrical and electrochemical performance along with required thermal management, mechanical integrity, and dimensional constraint (if any) to meet operating requirements of specified power generation applications.⁴

A wide range of fabrication processes have been investigated for making SOFC cells. Fabrication processes developed for the SOFC include conventional ceramic processing methods (e.g., tape casting, tape calendaring, screen printing, and extrusion) and deposition techniques (e.g., plasma spraying, spin coating, dip coating, electrochemical vapor deposition, electrophoretic deposition).⁴ The key step in any selected process is the fabrication of

(continued on next page)

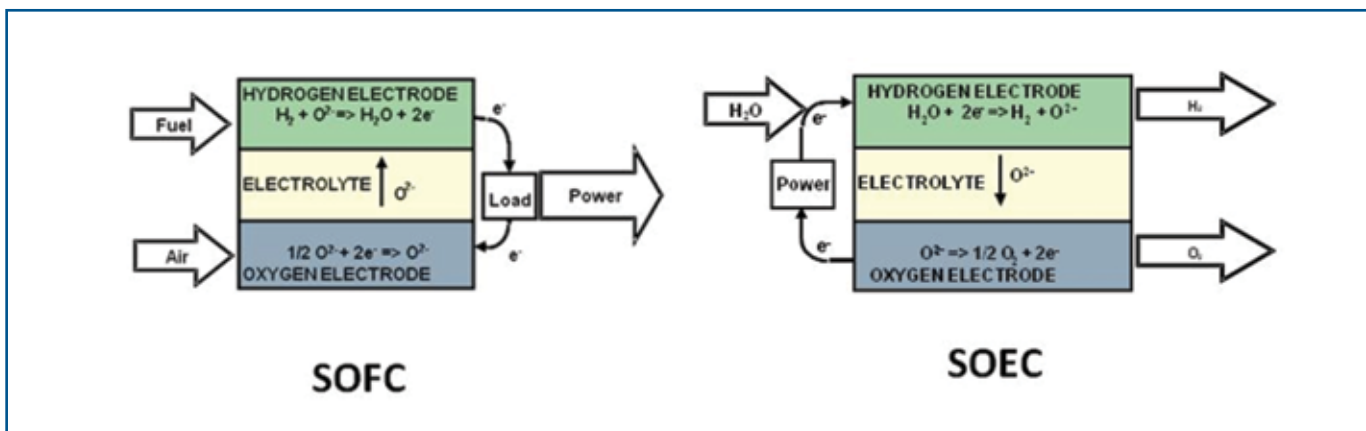

FIG. 1. Operating Principles of an RSOFC (written for hydrogen fuel in SOFC mode and steam electrolysis in SOEC mode).

dense electrolytes and the fabrication process selected depends on the configuration of the cells in the stack.

One of the key attributes of the SOFC is its multi-fuel capability. For fuels other than pure hydrogen, the SOFC can operate on reformates (via external reformation) or on hydrocarbons and other fuels (via internal reforming or direct utilization).⁵

The operating temperature of the SOFC can be varied by modifying electrolyte material and/or electrolyte thickness. Examples include operating temperatures of 900°-1000°C for thick (>50 micrometers) YSZ electrolytes,² 700°-800°C for thin (<15 micrometers) YSZ electrolytes² or doped lanthanum gallate electrolytes,⁶ 500°-600°C for thin doped ceria electrolytes,⁷ and 400°-500°C for thin doped ceria/bismuth oxide bilayer electrolytes.⁸

The SOFC has been considered for a broad spectrum of power generation applications and markets. Applications include power systems ranging from watt-sized devices to multimegawatt power plants and potential markets for the SOFC cover portable, transportation, and stationary sectors. Many of the applications for the SOFC have progressed to hardware demonstration and prototype/pre-commercial stages while several applications, especially those with large power outputs, are at the conceptual/design stage (Fig. 4). Significant advancements have been made in the past few years in several technological areas critical to the development and commercialization of the fuel cell: performance, fabrication scale-up and miniaturization, fuel utilization, and performance degradation and durability.

Performance.—SOFC single cells have exhibited peak power densities as high as 2 W/cm² at temperatures as low as 650°C (with hydrogen fuel and air oxidant, low fuel and air utilizations).⁸ SOFC stacks have demonstrated electrochemical performance under operating conditions appropriate for practical uses. For example, a 96-cell planar stack shows a power density of about 0.3 W/cm² (voltage of about 0.82 V per cell at 0.364 A/cm²), 715°C on air (15% air utilization), and fuel containing 25.2% H₂- 22.4% N₂-14.5% natural gas (NG)-37.8% H₂O (68% fuel utilization).⁹

For state-of-the-art SOFC single cells (having minimal ohmic resistance contributions from the components), cathode (oxygen electrode) polarization is generally the major contribution to cell performance losses. Thus, many cathode studies have been conducted to obtain a better understanding of the oxygen reduction reaction mechanisms and develop approaches to improve cathode performance.^{10,11} One major development in recent cathode R&D work is the demonstration of infiltration as a potent means for electrode performance enhancement.^{12,13} For example, infiltration

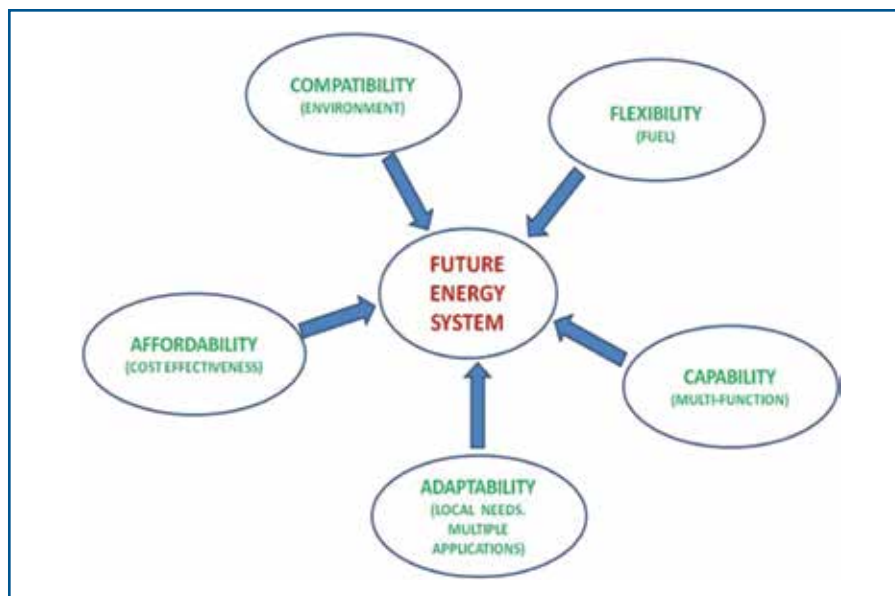

FIG. 2. Characteristics of a future energy system.

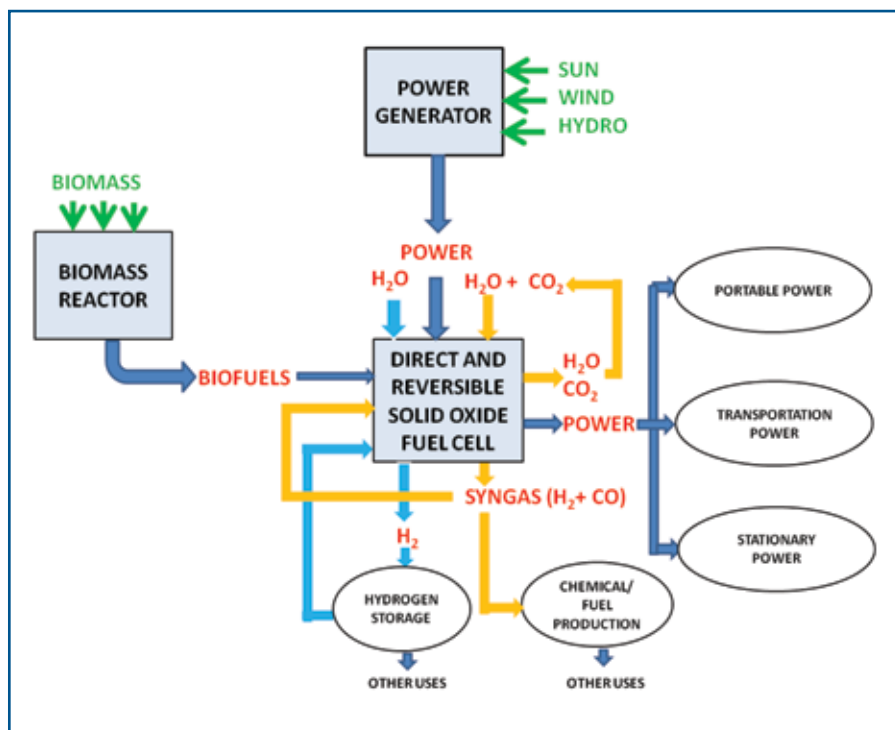

FIG. 3. An example of an RSOFC-based sustainable energy system.

of yttria-doped ceria (YDC) into LSM/YSZ cathode increased peak power density from 208 to 519 mW/cm² at 700°C and power density at 0.7V from 135 to 370 mW/cm².¹² Infiltration of active components as dispersed particles or connected nanoparticulate networks to form nanostructures enhances cathode performance by modifying catalytic activities and/or conduction pathways of the electrode. Use of nanostructures has also been shown to improve anode performance.¹⁴ The main issue is the stability of the nanostructure over extended periods of time at high operating temperatures. Operating

the SOFC at reduced temperatures (e.g., <600°C) or stabilizing the nanostructure are potential approaches to maintain sufficient long-term stability.^{12,15}

In SOFC stacks, especially planar stacks with metallic interconnects, contact resistance between the electrodes, especially the cathode, and the metallic interconnect is the major factor in stack performance losses¹⁶ and long-term performance degradation. The contact between the ceramic cathode and the metallic interconnect tends to change due to thermodynamic driving forces and other operating characteristics

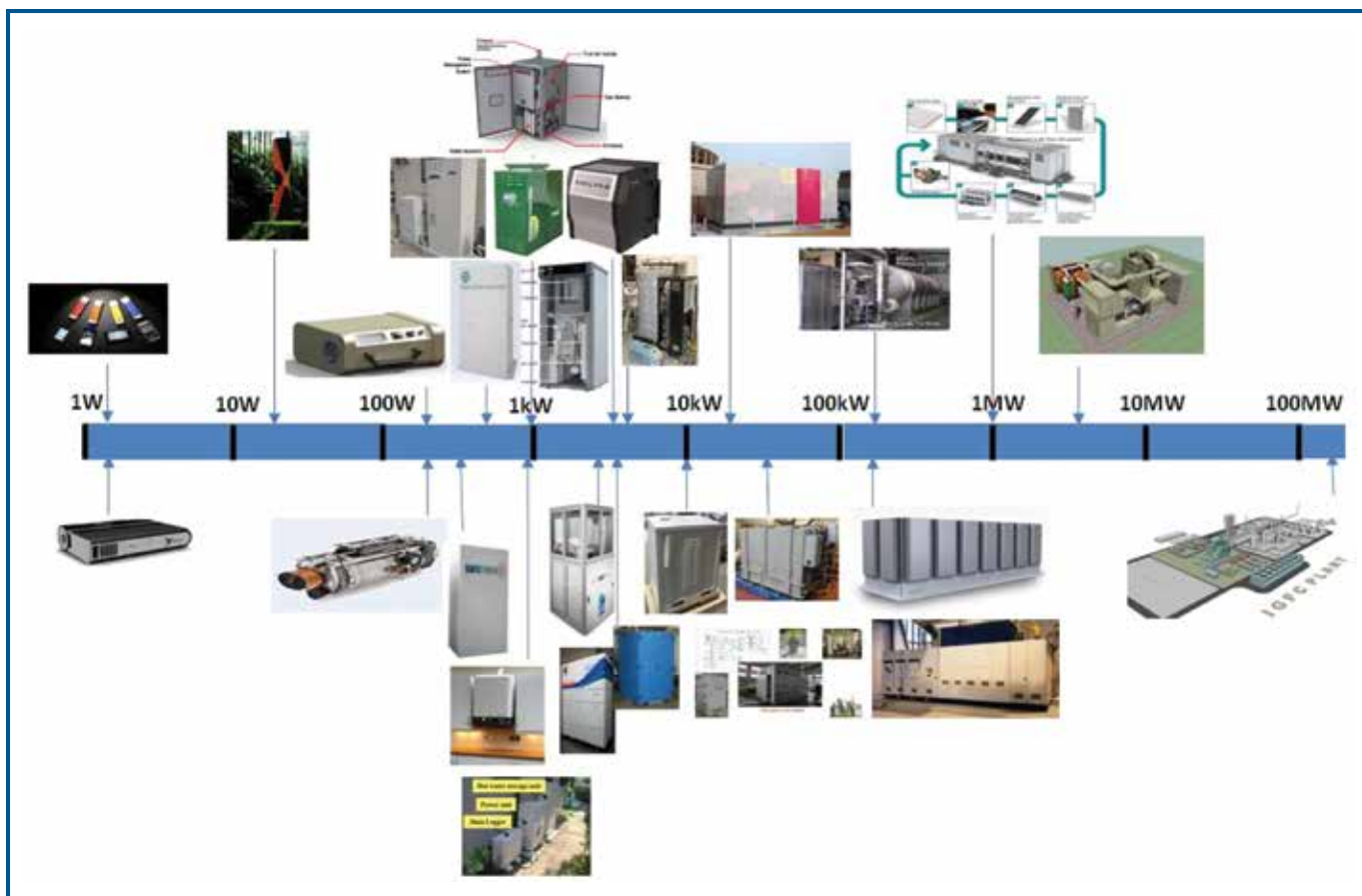

Fig. 4. SOFC power systems (hardware demonstrators, prototypes and pre-commercial systems up to 200 kW, concepts at 1MW and above).

such as temperature distribution, thermal expansion mismatch as operation proceeds. These factors can lead to degradation in long-term operation. It is highly possible that during long-term operation, chemical interaction develops and electrical contact between the cathode and the interconnect evolves, ohmic resistance increased and contact area reduced, resulting in higher ohmic losses and thus degradation (Fig. 5). Conductive contact pastes have been used in planar stacks to minimize contact resistance; however, stability of such contact pastes over long duration is questionable.

Fabrication scale-up and miniaturization.—Tubular SOFC cells (typical diameters of >15 mm) have been fabricated in full active length (e.g., 150 cm) and tubular cell stacks of up to 100 kW have been assembled.⁴ Planar SOFC cells, especially anode- (hydrogen electrode-) supported cells, have recently been scaled up to sizes having active areas (e.g., 500-1000 cm²) suitable for uses in large power systems. Manufacture of planar cells as large as 1200 cm² in total area has been demonstrated¹⁷ and planar SOFC stacks of up to 15 kW have been built and operated for thousands of hours. Segmented-cells-in-series SOFCs has been made into practical assembly/stack sizes (e.g., 60-cell assemblies of 60 W output¹⁸). These assemblies can be stacked and bundled to form modules of appropriate power levels. For example, 20 kW modules

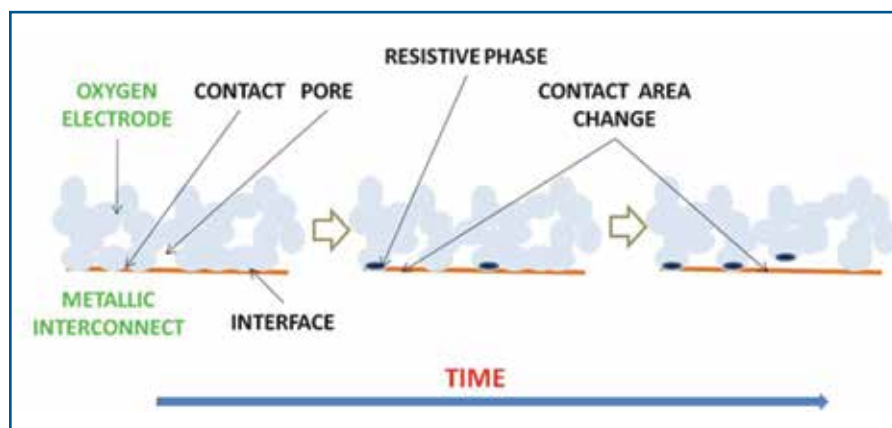

Fig. 5. Cathode (oxygen electrode)/metallic interconnect contact evolution.

suitable for 1 MW systems have been constructed from five strips of 12 parallel bundles of six 60-cell assemblies.¹⁸ SOFC stacks based on the monolithic design have been scaled up to 30 kW sizes.¹⁹

In addition to fabrication scale-up for large power systems, the SOFC has also been scaled down for certain applications such as consumer electronics devices and compact portable powers.²⁰ Miniature SOFCs being developed to date include micro-tubular (diameters of <5 mm) cells,²⁰ thin-film cells micro-fabricated on silicon wafers²⁰ and single-chamber SOFCs.²¹

The development of practical units based these miniature cells has made significant technical and commercialization progress with recent introduction of pre-commercial products, such as 5 V, 2.5 W mobile power,²² 12-24 V, 1-375 W portable power,²³ and 1.2 V, 4000 mAh SOFC charger.²⁴

Fuel utilization.—The SOFC can operate directly on fuels other than hydrogen (e.g., hydrocarbons, alcohols) via internal reforming (on fuel feeds with significant amounts of water) or direct utilization (on

(continued on next page)

fuel feeds with no water). Internal reforming using on-anode reformation is well known and has been demonstrated for the SOFC. Instead of complete (100 percent) internal reforming, it is possible to have a portion of the fuel reformed in an external reformer (referred to as a pre-reformer) and the resulting reformate plus the remaining fuel are fed to the SOFC where the fuel is internally reformed (via steam reforming) within the fuel cell. An example is the demonstration of operation of a 5 kW SOFC system with an auto-thermal reformation reformate containing about 7 volume% methane slip.²⁵ This pre-reforming/internal reforming option has been employed to use the endothermic reforming reactions to reduce cooling requirements in thermal management of the SOFC.

The SOFC has been shown in recent years to have the capability for direct utilization of different types of fuel.²⁶ For direct fuel utilization operation, the anode material has been modified to address the carbon deposition issue associated with nickel commonly used in the anode composition (e.g., Cu/ceria instead of Ni/YSZ²⁷). With modified anodes, high electrochemical performance can be achieved for direct SOFCs. For example, a peak power density of about 400 mW/cm² at 800°C was obtained with 7.3% ethanol balance He fuel and air oxidant for an anode-supported SOFC with a dual layer anode consisting of a Cu-CeO₂ impregnated Ni/YSZ support outer layer and a Ni/YSZ electroactive inner layer (Fig. 6).²⁸ Long-term performance stability of direct SOFCs without significant carbon deposition, however, remains to be demonstrated.

Performance degradation and durability.—SOFC single cells, when properly prepared with conventional high-purity materials and operated on clean fuels and air, show minimal performance degradation for extended periods of time. For example, tubular cells were electrically tested for times as long as eight years and showed satisfactory performance with less than 0.1% per 1000 h degradation.⁴ SOFC cells, however, can experience significant performance degradation in realistic environments, depending on several factors such as gas input purities and component materials used in the stack/system.²⁹ Sulfur is the most prevalent fuel impurity in many practical fuels and its poisoning effects on the Ni/YSZ anode are well known.³ It has also been shown that silicon impurities present in the fuel (originated from, for example, stack glass sealants or silica containing insulations in the system) can also poison the Ni/YSZ anode.³⁰ On the cathode side, presence of significant amounts of water or carbon dioxide in air can have deleterious effects on cell performance.^{31–33} Most of recent R&D activities on performance degradation have been focused on the chromium poisoning issue in long-term operation of planar stacks having metallic interconnects. Chromium present in the metallic interconnect can migrate to cathode reactive sites and interact with the cathode, poisoning the electrode thereby increasing cathode polarization with time. At present, the most common mitigating approach is to use conductive coatings (e.g., Co-Mn spinel) on the metallic interconnect to minimize the chromium transport and migration.³⁴

SOFC stacks and systems have been operated for tens of thousands of hours and durability has been demonstrated recently

with low performance degradation rates under specified operating conditions. For example, a short planar SOFC stack (with uncoated metallic interconnects) has been in operation at 700°C for more than five years with the overall voltage degradation of about 1% per 1000 h.³⁵ With coated metallic interconnects, a stack has been tested for more than 14000 h with a reduced degradation rate of about 0.12% per 1000 h.³⁵ Figure 7 is an example of performance of a 96-cell stack showing 1.3% voltage degradation per 1000 h (with internal reforming).⁹

Solid Oxide Electrolysis Cell Technology

The RSOFC functions as a SOEC when operated in electrolysis mode. The RSOFC thus can be used to produce hydrogen from H₂O,³⁶ syngas from mixtures of H₂O and CO₂,³⁷ and oxygen from CO₂.³⁸ The SOEC is the only electrolysis cell having this capability. The SOEC operating at high temperatures has the advantage that the electrical energy required for the electrolysis decreases as temperature increases and the unavoidable Joule heat is used in the water and/or carbon dioxide splitting process. Thus, the SOEC can work under the so-called thermoneutral condition, *i.e.*, at the thermoneutral voltage (V_{tn}), the electricity input exactly matches the total energy demand of the electrolysis reaction. In this case, the electrical-to-hydrogen conversion efficiency is 100%. At cell operating voltages $<V_{tn}$, heat must be supplied to the system to maintain the temperature and the conversion efficiency (based only on the electrical input) is above 100%. At cell operating voltages $>V_{tn}$, heat must be removed from the system and the efficiency is below 100%.

SOEC single cells have been shown to have the ability to perform well for hydrogen production from steam. For example, a cell voltage of 1.1 V (below V_{tn}) has been obtained for a Ni/YSZ supported SOEC cell of 45 cm² active area at a current density of about 1.4 A/cm², 900°C, 93% H₂O balance H₂.³⁹ Figure 8 summarizes data on current densities at the thermoneutral voltage reported in the literature for steam electrolysis between 500° and 900°C. Current density variations for the same material systems are due to starting material characteristics, processing, absolute humidity input, and flow rates. At higher temperatures ($>900^\circ\text{C}$), extraordinarily high current densities have been reported, *e.g.*, about 3 A/cm² at 1.3 V, 950°C.³⁷ SOECs have been shown capable of CO₂ electrolysis^{37,40} and syngas production by inputs of H₂O+CO₂ at similar current density ranges to steam electrolysis⁴¹ although the area specific resistance (ASR) for electrolysis of CO₂ is generally higher than that of H₂O.⁴² The mechanism for the CO₂ reduction is not well determined and may depend on the detailed structure of the electrode. In

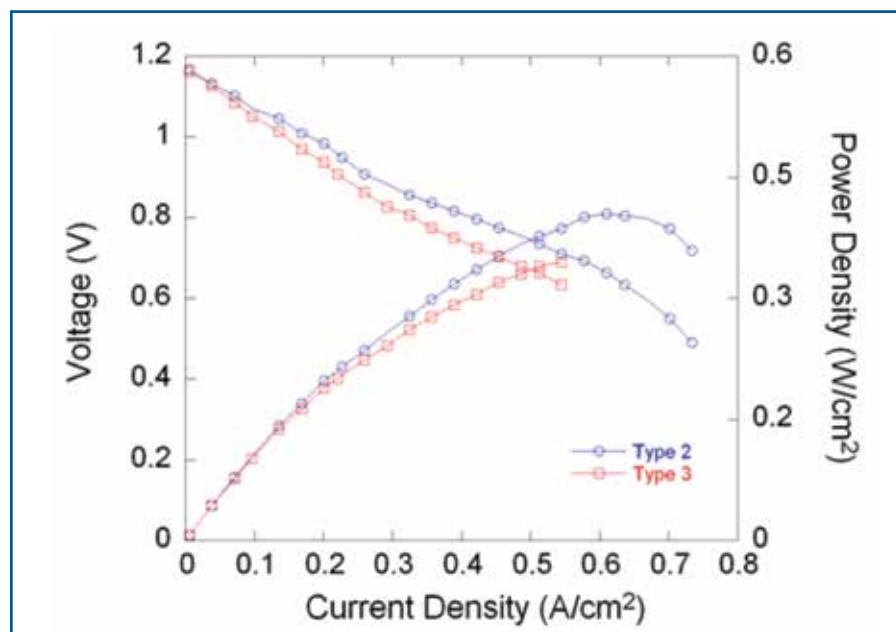

Fig. 6. Performance at 800°C with 7.3% ethanol balance He fuel and air oxidant for an anode-supported SOFC (with a dual layer anode consisting of a Cu-CeO₂ impregnated Ni/YSZ support outer layer and a Ni/YSZ electroactive inner layer). (Type 2 and 3 indicates different thermal treatments of infiltrated anodes).²⁸

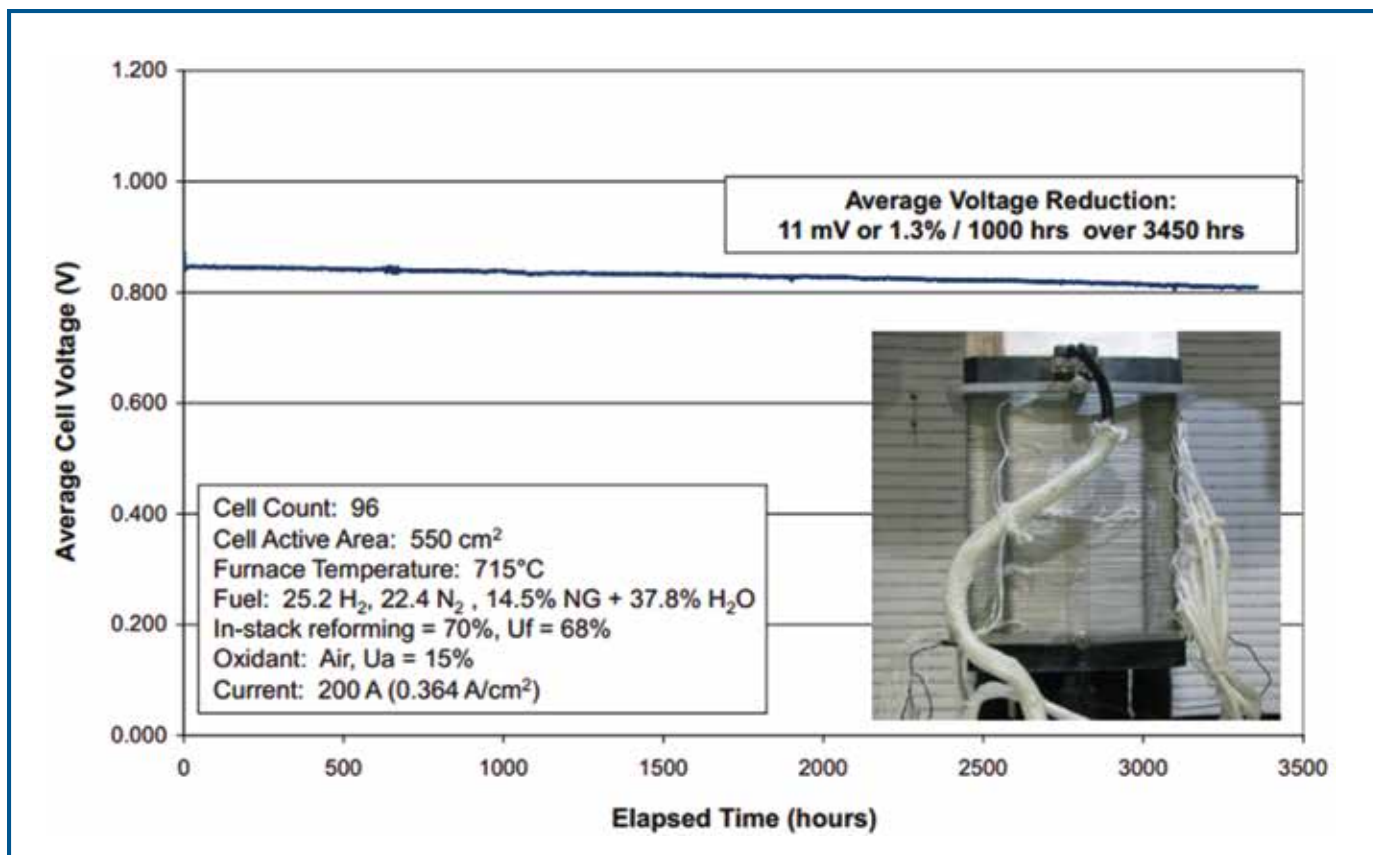

Fig. 7. Long-term performance of 96-cell planar stack.⁹

the case of H_2O+CO_2 , it is possible that only H_2O is involved in the electrochemical reaction and the CO_2 in the mixture reacts with H_2 of the reaction products via a reverse water gas shift reaction.

SOEC cells are commonly derived from cells developed for fuel cell operation. In general, such cells can operate stably

in electrolysis mode with no or minor modifications. However, an oxygen electrode that works stably in SOFC mode may experience rapid performance decay in electrolysis mode due to electrode delamination caused by oxygen evolution at the electrode/electrolyte interface.⁴³ This type of degradation has been observed for

oxygen electrodes based on predominantly electronic conducting oxides (e.g., LSM) when not designed to minimize oxygen pressure built-up at the interface during operation. For oxygen electrodes based on mixed ionic electronic conducting oxides (e.g., LSCF) with similar microstructures, electrode delamination may occur but at higher current densities (because of lower electrode overvoltage due to the spreading of triple phase boundary active sites on the mixed conducting surface). Long-term degradation of SOEC cells is generally higher than that obtained for similar cells in fuel cell mode.⁴⁴ Root causes for this difference, however, are not fully understood.

SOEC single cells and multi-cell stacks have been operated and hydrogen/syngas production (from H_2O/H_2O+CO_2) has been demonstrated in laboratory scale. To date, planar cells as large as 20 cm x 20 cm size, stacks as tall as 60-cell height and a 15 kW laboratory facility have been fabricated and hydrogen production rates as high as 5.7 Nm^3/h have been achieved.⁴² SOECs have been tested up to 2500 h and performance degradation is typically in the order of 5-10% per 1000 h. A recent SOEC work reports low degradation (<1% per 1000 h) for electrolysis of H_2O+CO_2 at current densities below 0.7 A/cm^2 (Fig. 9).⁴⁵

The SOEC has been considered for hydrogen production from steam^{36,46} at distributed plant (e.g., 1,500 kg H_2/day)

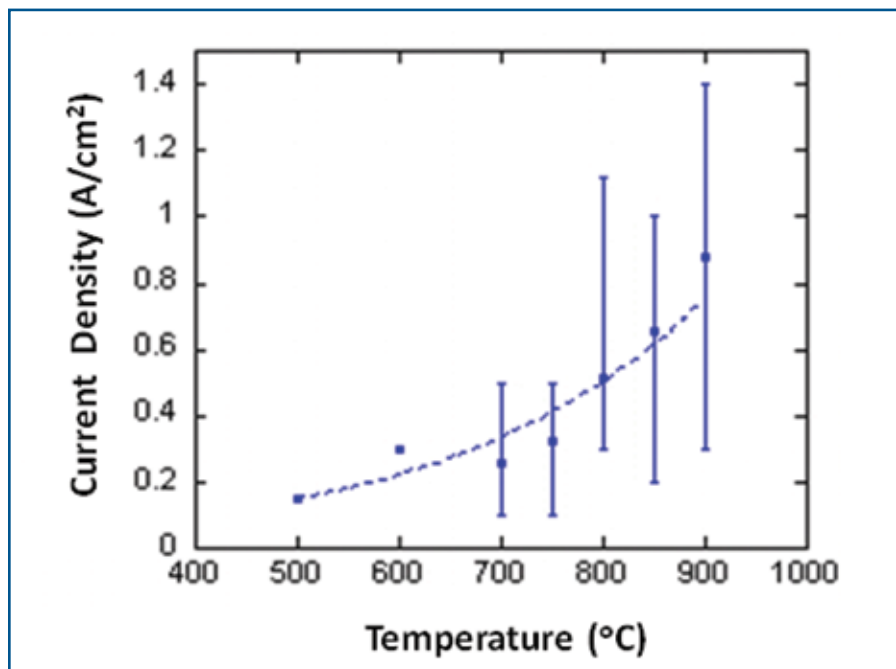

Fig. 8. Current densities at thermoneutral voltage reported for SOECs between 500° and 900°C (the bars show the range of values).

(continued on next page)

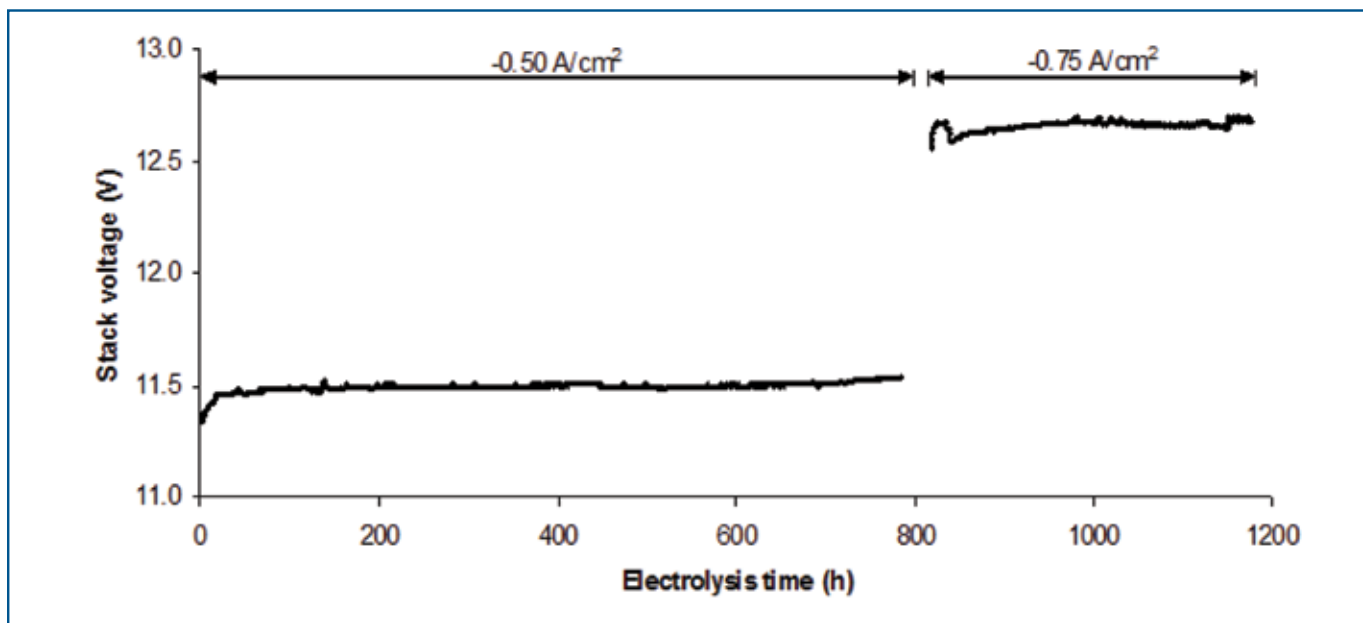

Fig. 9. Voltage as function of time for 1 kW 10-cell sStack of 12 cm x 12 cm footprint. Temperature = 850°C, gas input = 10% H₂-45% H₂O-45% CO₂.⁴⁵

and central station (e.g., 150,000 kg H₂/day) sizes,⁴³ syngas production for industrial uses,⁴⁷ and oxygen generation/recovery for space applications.^{48,49} Integration of SOEC systems with nuclear⁵⁰ and renewable energy resources such as solar energy⁵¹ has been envisioned. Figure 10 shows a concept of a SOEC-based hydrogen production central system coupled with high-temperature gas-cooled nuclear reactors.⁵² Figure 11 is an example of a concept combining SOECs with biomass based plant.⁵³ In this concept, oxygen produced in the SOEC unit can be used for the gasification of biomass, and steam for the SOEC can be generated in the gasification plant. The SOEC generates hydrogen that is needed for conversion of all the carbon in the biomass to chemicals such as methanol (MeOH), dimethyl ether (DME), gasoline, and synthetic natural gas (SNG). This concept also includes a method of upgrading digested biogas using co-electrolysis of CO₂ (present) and steam (added) in biogas.

Reversible Solid Oxide Fuel Cell Technology

An RSOFC must operate efficiently in both SOFC and SOEC modes. Thus, two key requirements for RSOFCs, addition to those specified for SOFC/SOEC operation, are (1) acceptable electrode performance reversibility and stability, and (2) efficient and stable cyclic operation.

Electrode performance reversibility and stability for reversible operation.— In general, the hydrogen electrode shows performance reversibility (symmetry) between fuel cell and electrolysis modes. The oxygen electrode, on the other hand, shows

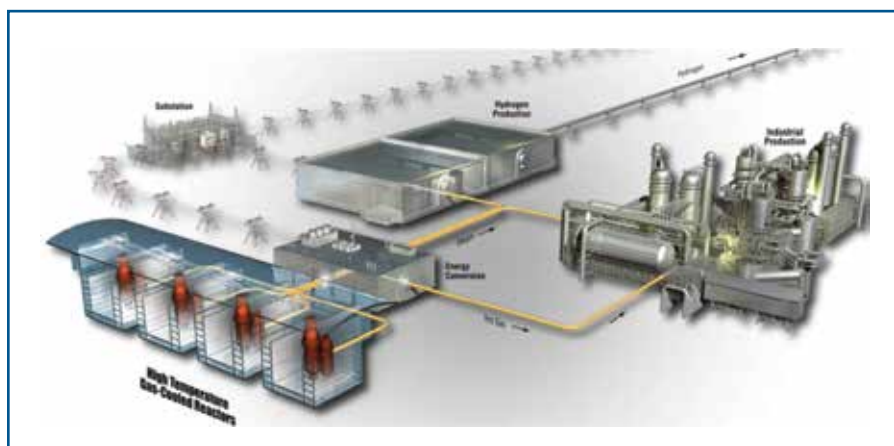

Fig. 10. Concept for large-scale centralized nuclear hydrogen production.⁵²

performance reversibility at low current densities but may exhibit irreversibility at higher current densities in electrolysis mode depending on a number of factors such as electrode microstructure, material and operating parameter.⁴³ Performance stability of the electrodes is very much dependent on electrode microstructures. Oxygen electrode microstructures must be designed to circumvent oxygen pressure build-up at electrode/electrolyte interfaces during electrolysis. Hydrogen electrode microstructures must be engineered to facilitate both water and hydrogen transport to and from reaction sites.

Efficient and stable cyclic operation.— RSOFC single cells and multi-cell stacks have been built and tested and their cyclic operation has been demonstrated. Cell and stack performance in electrolysis mode

typically shows higher degradation rates than those in fuel cell mode.^{43,54,55} Figure 12 shows an example of a 10-cell RSOFC stack and its performance (in terms of ASR) in operation for more than 1000 h (operating alternately between internal reforming fuel cell mode and steam electrolysis mode).¹⁶ This stack showed an initial power density of 480 mW/cm² at 0.7V, 800°C with 64% H₂ - 35% N₂ as fuel and 80% fuel utilization in fuel cell mode and produced about 6.3 standard liter per minute of hydrogen at 1.26 V cell voltage, 0.62 A/cm² with 30% H₂ - 70% H₂O and steam utilization of about 54%.

The RSOFC is at its early stage of development and to date, only limited work, mainly in laboratory scale, has been conducted on this technology. Advancements in RSOFCs will continue to leverage

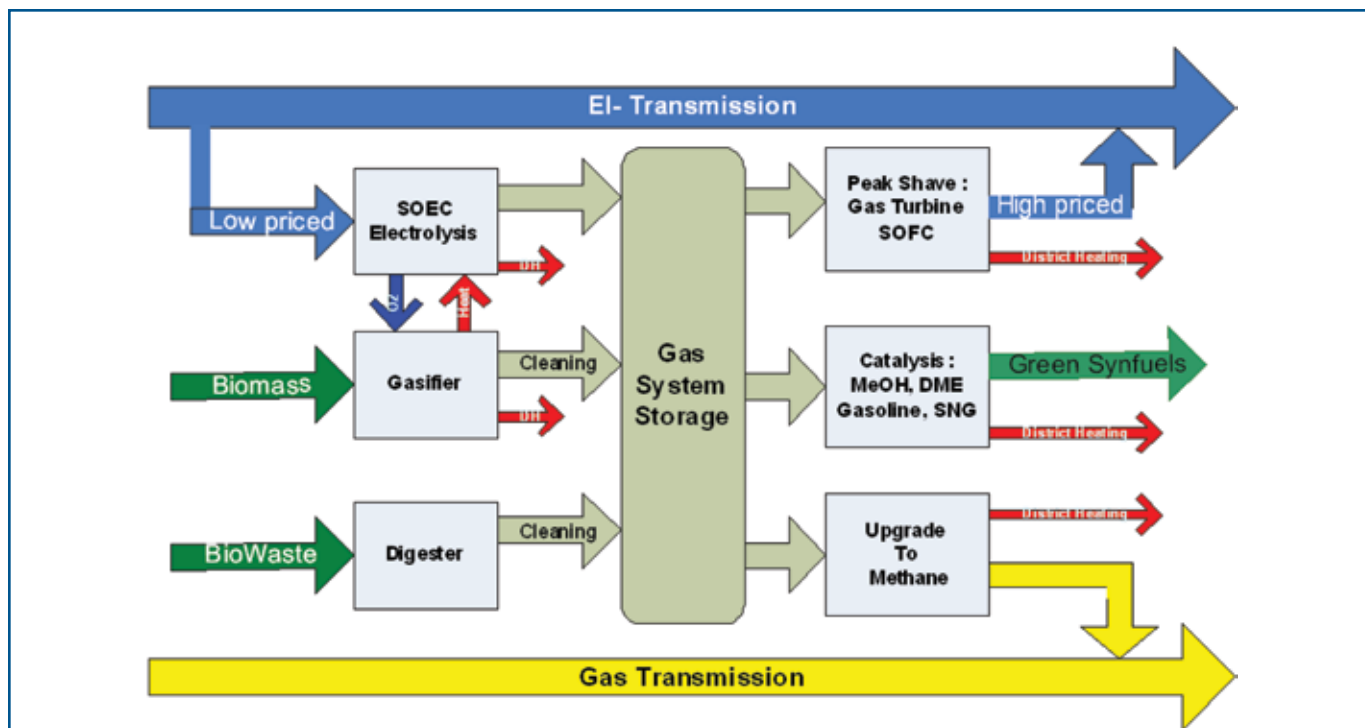

Fig. 11. Concept combining SOEC, biomass gasifier, and biomass digester.⁵³

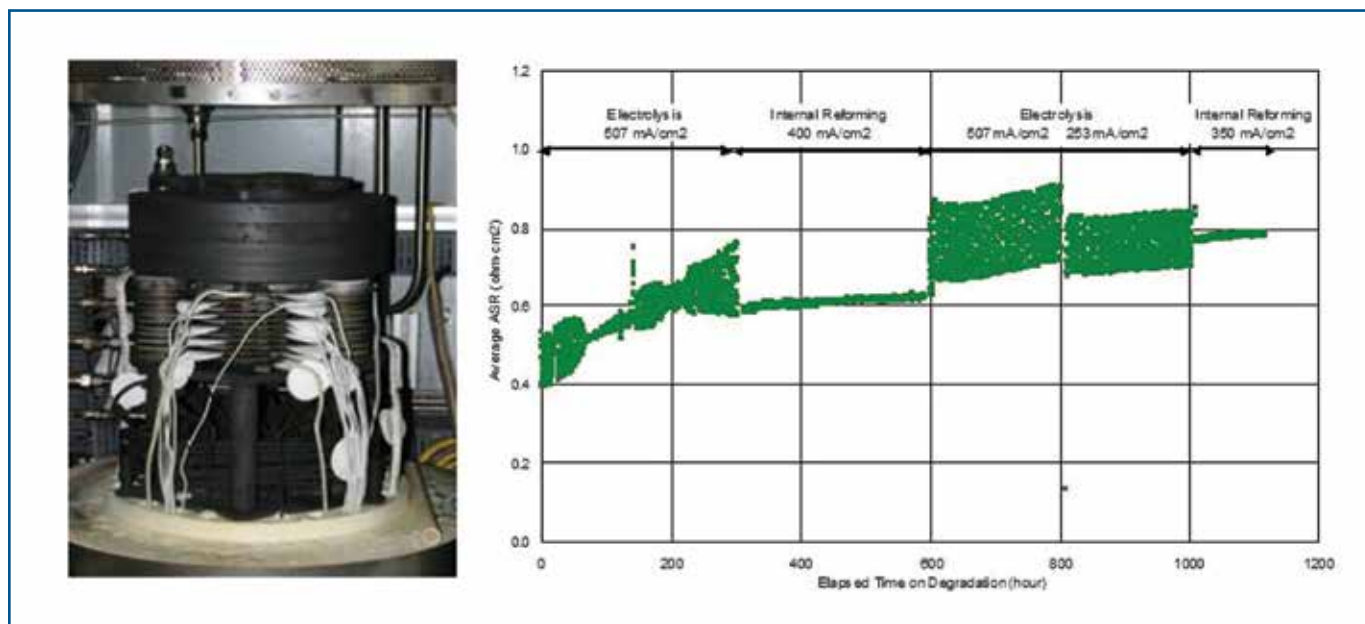

Fig. 12. Photograph of 10-cell stack (cell active area of 142 cm²) and stack ASR in methane internal reforming fuel cell mode and steam electrolysis mode (fluctuations seen in steam electrolysis due to instability of steam generation and delivery).¹⁶

progress in SOFC/SOEC technology. However, certain R&D is required to address several critical issues specific to the RSOFC, such as oxygen electrode performance and reversibility, a set of materials, cell/stack designs and operating parameters suitable for reversible operation, and system design and integration to demonstrate the feasibility of the technology. This will serve as a basis for further development to advance the technology toward practical applications. ■

About the Authors

NGUYEN Q. MINH is currently Associate Director, Center for Energy Research at the University of California, San Diego. Previously he was Chief Scientist and Manager, Fuel Cells at GE and Honeywell/AlliedSignal. His experience covers a full spectrum of SOFC research and product R&D areas, ranging from technology assessment, strategy/roadmap formulation,

fundamental/engineering study to materials/processes/manufacturing development, system design/operation, and prototype demonstration. He may be reached at nminh@ucsd.edu.

MOGENS B. MOGENSEN has been employed at Risoe National Laboratory since April 1980. He has had several duties as project manager, section head, group leader, and center leader in parallel to his engagement

(continued on next page)

in energy research. He became Research Professor June 2003, and he withdrew from personnel management in 2006 to devote all time to R&D. His main research area since 1989 has been solid oxide fuel cells and electrolyzer cells. He has over 225 papers registered by Web of Science (h-index 44); and more than 600 registered by Google Scholar (h-index 51). Almost all of his research has been carried out in close cooperation with industry. He may be reached at momo@dtu.dk.

References

- N. Q. Minh, in *10th European SOFC Forum*, Paper A1106, Lucerne, Switzerland (2012).
- N. Q. Minh and T. Takahashi, *Science and Technology of Ceramic Fuel Cells*, Elsevier Science, Amsterdam, The Netherlands (1995).
- S. C. Singhal and K. Kendall, Editors, *High Temperature Solid Oxide Fuel Cells: Fundamentals, Design and Applications*, Elsevier, Oxford, UK (2003).
- K. Kendall, N. Q. Minh, and S. C. Singhal, in *High Temperature Solid Oxide Fuel Cells: Fundamentals, Design and Applications*, S. C. Singhal and K. Kendall, Editors, p. 197, Elsevier, Oxford, UK (2003).
- N. Q. Minh, in *Fuel Cell Science and Engineering, Materials, Processes, Systems and Technology*, Vol. 2, D. Stolten and B. Emonts, Editors, p. 963, Wiley-VCH, Weinheim, Germany (2012).
- T. Akbay, in *Perovskite Oxide for Solid Oxide Fuel Cells*, T. Ishihara, Editor, p. 183, Springer, New York, NY (2009).
- M. C. Tucker, *J. Power Sources*, **195**, 4570 (2010).
- E. D. Wachsman and K. T. Lee, *Science*, **334**, 935 (2011).
- H. Ghezal-Ayagh, in *13th Annual SECA Workshop*, www.netl.doe.gov/publications/proceedings/10/seca/index.html (2012).
- National Energy Technology Laboratory, *Recent Solid Oxide Fuel Cell Cathode Studies*, Report DOE/NETL-2013/1618 (2013).
- J. Hayd, L. Dieterle, U. Guntow, D. Gerthsen, and E. Ivers-Tiffée, *J. Power Sources*, **196**, 7263 (2011).
- T. Z. Sholkapper, C. P. Jacobson, S. J. Visco, and L. C. De Jonghe, *Fuel Cells*, **5**, 303 (2008).
- J. M. Vohs and R. J. Gorte, *Adv. Mater.*, **21**, 943 (2009).
- C. Ding, H. Lin, K. Sato, T. Kawada, J. Mizusaki, and T. Hashida, *Solid State Ionics*, **181**, 1238 (2010).
- Y. Gong, D. Palacio, X. Song, R. L. Patel, X. Liang, X. Zhao, J. B. Goodenough, and K. Huang, *Nano Lett.*, DOI: 10.1021/nl402138w (2013).
- N. Q. Minh, *J. Korean Ceram. Soc.*, **47**, 1 (2010).
- M. J. Day, S. L. Swartz, and G. B. Arkenberg, *ECS Trans.*, **35**(1), 385 (2011).
- R. Goettler and T. Ohm, in *11th Annual SECA Workshop*, www.netl.doe.gov/publications/proceedings/10/seca/index.html (2010).
- www.mhi.co.jp/en/technology/business/power/sofc/development_situation.html
- E. Traversa, *Interface*, 49 (Fall 2009).
- M. Kuhn and T. W. Napporn, *Energies*, **3**, 27 (2010).
- www.nectarpower.com
- www.ezelleron.eu
- www.pointsourcepower.com
- GE Hybrid Power Generation Systems, *Solid State Energy Conversion Alliance (SECA) Solid Oxide Fuel Cell Program*, Final Report (2006).
- S. Park, J. M. Vohs, and R. J. Gorte, *Nature*, **404**, 265 (2000).
- S. McIntosh and R. J. Gorte, *Chem. Rev.*, **104**, 4845 (2004).
- E. N. Armstrong, J.-W. Park, and N. Q. Minh, *Electrochem. Solid-State Lett.*, **15**, B75 (2012).
- H. Yokokawa, K. Yamaji, M. E. Brito, H. Kishimoto, and T. Horita, *J. Power Sources*, **196**, 7070 (2011).
- Y. L. Liu, S. Primdahl, and M. Mogensen, *Solid State Ionics*, **161**, 1 (2003).
- S. H. Kim, T. Ohshima, Y. Shiratori, K. Itoh, and K. Sasaki, in *MRS Proceedings*, Volume 1041, V. Pthenakis, A. Dillon and N. Savage, Editors, 1041-R03-10, Materials Research Society, Warrendale, PA (2007).
- A. Hagen, K. Neufeld, and Y. L. Liu, *J. Electrochem. Soc.*, **157**, B1343 (2010).
- W. Zhou, F. Liang, Z. Shao, and Z. Zhu, *Scientific Reports*, **2**:327, DOI: 10.1038/srep00327 (2012).
- N. Q. Minh, S. C. Singhal, and M. C. Williams, *ECS Trans.*, **17**(1), 211 (2009).
- L. Blum, U. Packbier, I. C. Vinke, and L. G. J. de Haart, *Fuel Cells*, **13**, 646 (2013).
- A. Hauch, S. D. Ebbesen, S. H. Jensen, and M. Mogensen, *J. Mater. Chem.*, **18**, 2331 (2008).
- S. H. Jensen, P. H. Larsen, and M. Mogensen, *Int. J. Hydrogen Energy*, **32**, 3253 (2007).
- J. Guan, R. Doshi, G. Lear, K. Montgomery, E. Ong, and N. Minh, *J. Am. Ceram. Soc.*, **85**, 2651 (2002).
- A. Brisse, J. Scheffold, and M. Zahid, *Int. J. Hydrogen Energy*, **33**, 5375 (2008).
- S. D. Ebbesen and M. Mogensen, *J. Power Sources*, **193**, 349 (2009).
- J. Hartvigsen, L. Frost, and S. Elangovan, www.fuelcellseminar.com/media/51332/sta44-4.pdf (2012).
- C. M. Stoots, J. E. O'Brien, K. G. Condie, and J. J. Hartvigsen, *Int. J. Hydrogen Energy*, **35**, 4861 (2010).
- GE Hybrid Power Generation Systems, *High Performance Flexible Reversible Solid Oxide Fuel Cell*, Final Technical Report (2008).
- A. Hauch, S. H. Jensen, S. D. Ebbesen, and M. Mogensen, in *Energy Solutions for Sustainable Development Proceedings, Risø Energy International Conference 2007*, Risø-R-1608 (EN), L. S. Petersen and H. Larsen, Editors, p. 327, Risø National Laboratory Technical University of Denmark, Roskilde, Denmark (2007).
- S. D. Ebbesen, J. Høgh, K. A. Nielsen, J. U. Nielsen, and M. Mogensen, *Int. J. Hydrogen Energy*, **36**, 7363 (2011).
- B. Yu, W. Q. Zhang, J. Chen, J. M. Xu, and S. R. Wang, *Sci. China Ser. B-Chem.*, **51**, 289 (2008).
- Q. Fu, in *Syngas: Production, Applications and Environment Impact*, A. Indarto and J. Palgunadi, Editors, p. 209, Nova Science Publishers, Hauppauge, NY (2011).
- K. R. Sridhar and R. Foertner, *J. Propul. Power*, **16**, 1105 (2000).
- D. Weng and S. Yates, AIAA Paper 2010-8675, American Institute of Aeronautics and Astronautics, Reston, VA (2010).
- R. Rivera-Tinoco, C. Mansilla, C. Bouallou, and F. F. Werkoff, *Int. J. Nuclear Hydrogen Production and Applications*, **1**, 249 (2008).
- J. P. Padin, T. N. Veziroglu, and A. Shabin, *Int. J. Hydrogen Energy*, **25**, 295 (2000).
- J. E. O'Brien, X. Zhang, C. R. O'Brien, and G. Tao, www.fuelcellseminar.com/media/9066/hrd34-5.pdf (2011).
- M. Mogensen, S. H. Jensen, S. D. Ebbesen, A. Hauch, C. Graves, J. V. T. Høgh, X. Sun, S. Das, P. V. Hendriksen, J. U. Nielsen, A. H. Pedersen, N. Christiansen, and J. B. Hansen, in *2012 World Gas Conference, Kuala Lumpur, Malaysia (2012)*.
- G. Tao and A. V. Virkar, www1.eere.energy.gov/hydrogenandfuelcells/pdfs/rev_fc_wkshp_tao.pdf (2011).
- C. Brown, www1.eere.energy.gov/hydrogenandfuelcells/pdfs/rev_fc_wkshp_brown.pdf (2011).